

electriQ

USER MANUAL

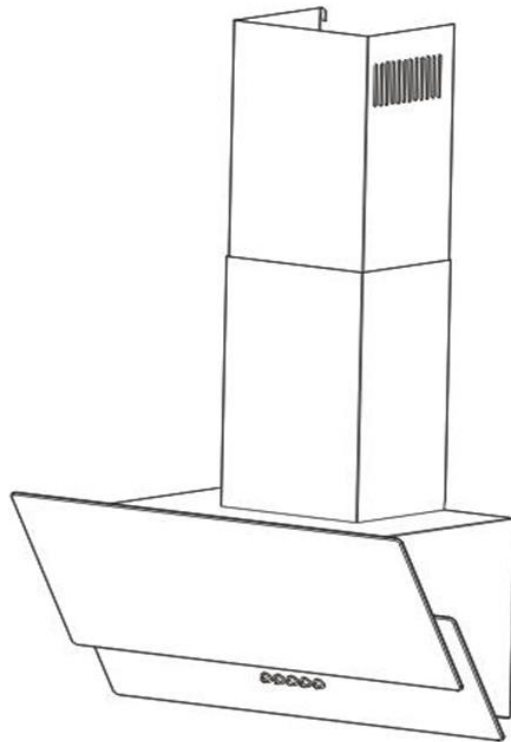

COOKER HOOD

eiQTMS60BL eiQTMS90BL eiQTMS60SS

Thank you for choosing electriQ
Please read this user manual before using this
product and keep it safe for future reference.
Visit our page www.electriQ.co.uk for our entire product range

CONTENTS

SAFETY	3
VENTILATION	5
BEFORE USE	6
PRODUCT OVERVIEW	7
INSTALLATION	8
FILTERS	11
OPERATION	12
CLEANING AND MAINTENANCE	13
LIGHT BULB REPLACEMENT	14
TROUBLESHOOTING	15
TECHNICAL SPECIFICATION	16
SUPPORT	17

SAFETY PRECAUTIONS

Whilst this product is compliant with all safety requirements, incorrect or inappropriate use can lead to both personal injury and potential damage to property. Please read the contents of this instruction booklet thoroughly before fitting or using this appliance.

- The cooker hood must be installed in accordance with the installation instructions and all measurements followed.
- All installation work must be carried out by a competent person or qualified electrician.
- The unit must be connected to an earthed power supply.
- If venting externally, make sure the ducting has no bends sharper than 90 degrees as this will reduce the efficiency of the cooker hood.
- The cooker hood is for domestic use only and is not designed for commercial use. It should only be used for the purpose it was intended – to extract vapours and cooking odours.
- Do not flambé or use an open flame under the cooker hood.
- Do not try to use the cooker hood without the grease filters or if the filters are excessively greasy. They should be cleaned regularly (see “Maintenance”) or replaced as necessary.
- The extraction fan must be level to avoid grease collection at one end, as this could cause a potential fire risk.
- Do not leave frying pans unattended during use because overheated fat or oils might catch fire.
- If the cooker hood is damaged, do not attempt to use it.
- If the supply cord is damaged, it must be replaced by the manufacturer, its service agent or a similarly qualified person in order to avoid a hazard.
- This appliance can be used by children aged from 8 years and above and persons with reduced physical, sensory or mental capabilities or lack of experience and knowledge if they have been given supervision or instruction concerning use of the appliance in a safe way and understand the hazards involved.
- Children shall not play with the appliance. Cleaning and user maintenance shall not be made by children without supervision.
- Children should be supervised to ensure that they do not play with the appliance. It is not a toy.
- The plug must be accessible after installation for isolation in case of an emergency – or an appropriate fused switch if the unit is hard-wired to the mains via a spur.

- The minimum distance between the surface of the hob and the lowest part of the hood should be at least 65cm. A distance of between 65cm and 75cm gives peak efficiency.
- The air must not be discharged into a flue that is used for exhausting fumes from appliances burning gas or other fuels.
- When the hood is vented externally and used with appliances which burn fuel (e.g. gas, oil, wood) the area must be sufficiently ventilated to ensure safe operation. Fresh air must be allowed to freely enter the room to prevent a partial vacuum.
- A partial vacuum can starve the heating appliance of oxygen, impairing combustion. It can also prevent toxic fumes from leaving the room, or can cause fumes to be sucked into the room from outside.
- Safe operation is only possible when the partial vacuum within the working area does not exceed 4 Pa (0.04 mbar). This can be achieved by ensuring air is able to enter the room from outside through a suitable sized opening which cannot be sealed during operation. A number of alternative solutions are available to ensure this. If in any doubt, professional advice should be sought.
- Regulations concerning the discharge of air have to be fulfilled.
- There is a potential fire risk if cleaning is not carried out in accordance with the instructions.
- Clean your appliance periodically by following the method given in the chapter MAINTENANCE
- If used in recirculation mode, the charcoal filters trap odours and must be replaced at least once a year depending on how frequently the cooker hood has been used.
- For safety reasons, please use only the same size of fixing or mounting screw, which are recommended in this instruction manual.
- Warning: Failure to install the screws or fixing device in accordance with these instructions may result in electrical hazards

CAUTION: Accessible parts of the hood can become very hot during use with cooking appliances, whether in use or not, due to heat rising from the hob. Sufficient time should be allowed for the unit to cool before touching either the housing or the grease filters

OPTIONS FOR VENTILATION

This hood can be set up for either external venting or recirculation of the air. The type of setup should be decided before commencing installation.

EXTERNAL VENTING

If you have an outlet to the outside, your cooker hood can be connected as shown in the diagram using any suitable extraction duct (enamel, aluminium, flexible pipe or inflammable material with an interior diameter of 150mm) can be used.

An adaptor is supplied to enable you to connect your hood to pre-existing 120mm diameter ducting.

If this is the chosen installation method consideration to the route of the vent pipe should be made prior to installation.

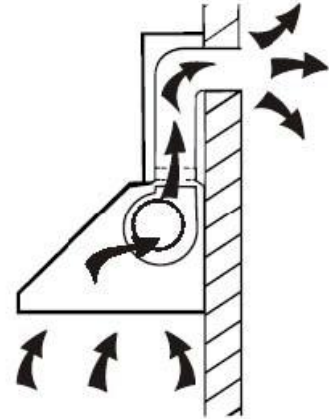

RECIRCULATION

This cooker hood also supports the recirculation of air once it has passed through the filters. The filtered air is then expelled through the vent holes in the side of the chimney.

When setting the unit up in this configuration, carbon filters should also be used to remove odours from the air. Details of sourcing and fitting the filters can be found in the Carbon filter section.

When setting up for recirculation the installation instructions should be followed, but a vent pipe should not be attached, and instead the air can be routed back into the room through the top of the unit.

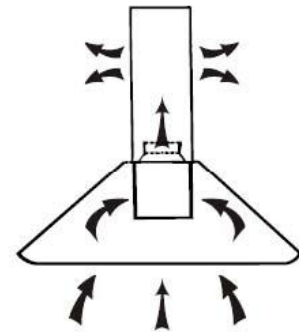

BEFORE USAGE

Before usage, read all the instructions and make sure that the voltage (V) and the frequency (Hz) indicated on the identification plate (found inside the cooker hood) and all the data inside the appliance are exactly the same as the voltage and frequency in your home.



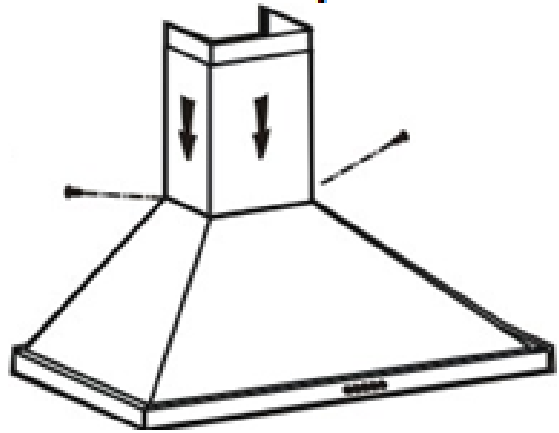





Plug the power lead into the power socket (or if connecting directly to the mains via a switched spur, ensure the work is carried out by a competent, qualified person) and the cooker hood is then ready for use.

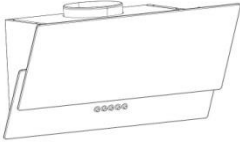
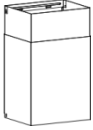

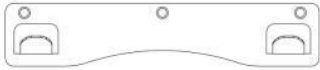
UNPACKING YOUR APPLIANCE

- Please take great care when unpacking; a sharp blade should not be used to open the box, as it may go deep enough inside to damage components. Components damaged or marked by careless unpacking are not covered under the guarantee.
- Carefully unpack the contents and check against the section below (Parts) and the next section (Product overview).
- Packaging materials should be recycled in accordance with local regulations

PRODUCT OVERVIEW - PARTS SUPPLIED

Description	Illustration	Qty.
Cooker hood		1
Chimney		2
Adaptor		1
Cable tie		1
Wall bracket		1
Plate I		1
Plate II		1
Screw (4mm x 30mm)		9
Wall plug		9
Air Flaps		2
Screw (3mm x 10mm)		2

INSTALLATION

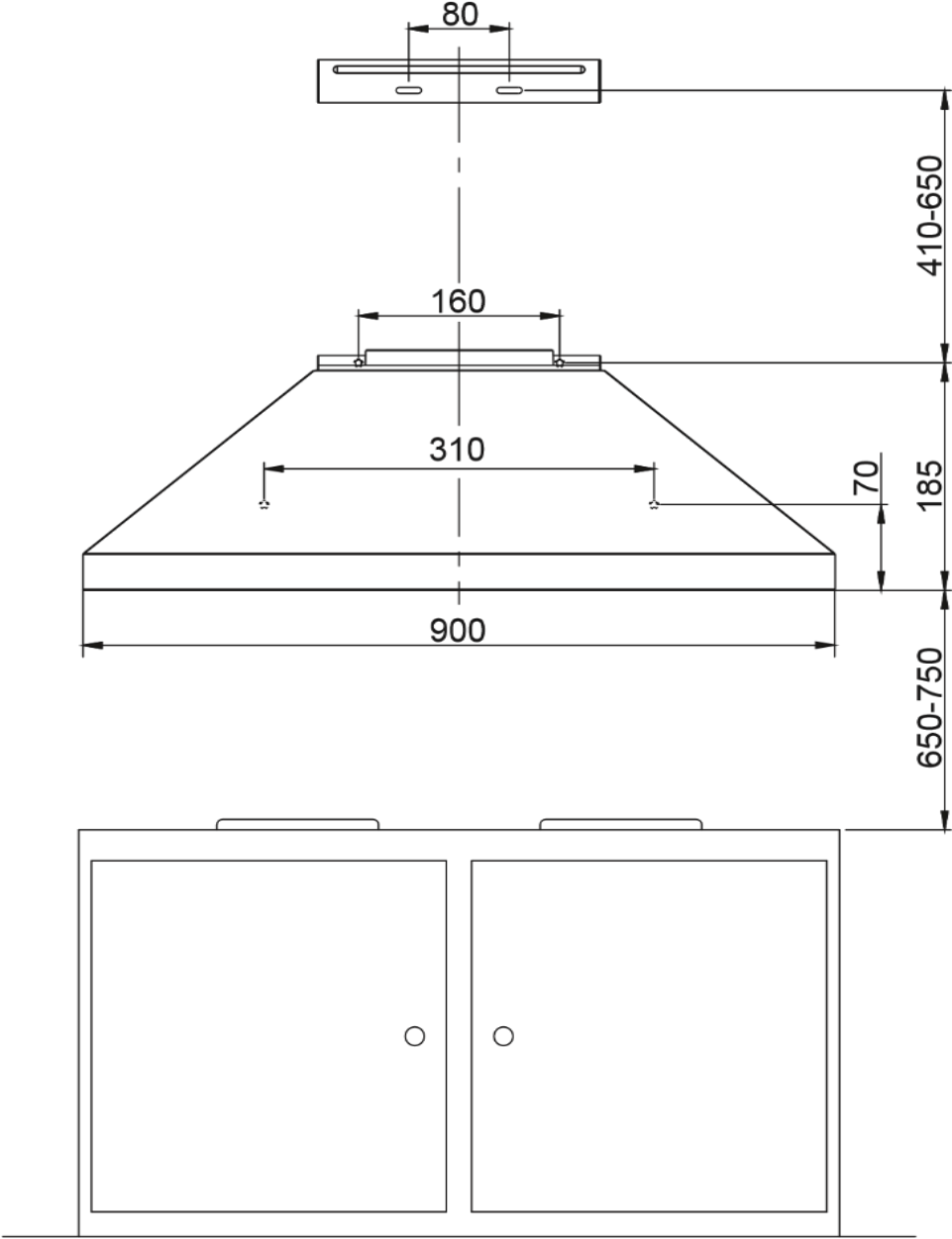

INSTALLATION

Before installation, ensure you have not connected the appliance to the mains supply.

1. The base of the cooker hood should be placed at a distance of 70~80cm above the cooking plane for best performance.

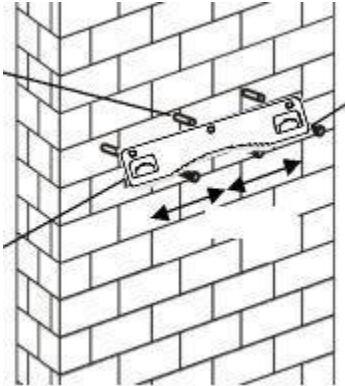
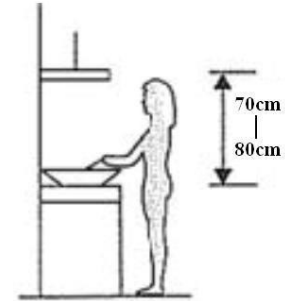

2. Drill 3 holes to accommodate the wall bracket. Screw and tighten the wall bracket onto the wall with the screws (4mm x 30 mm) and wall plugs provided.

3. Hang the appliance onto the wall bracket hook and fix the appliance using the 2 screws (4mm x 30mm).

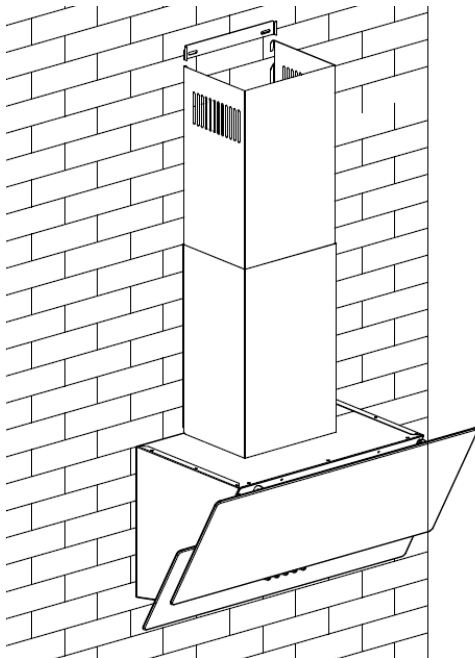
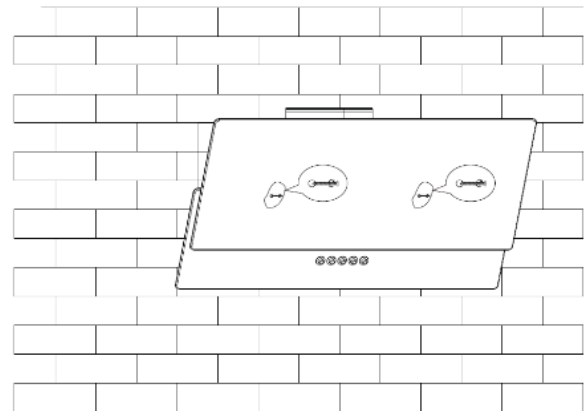

5. Plates I and II are used to fix the chimney onto the wall. Slide the inner chimney on to the outer chimney and place in position on top of the hood. Mark the position for plate II. Then slide the inner chimney upwards to the desired height, and mark the location for plate I.

6. The holes to accommodate the two plates can then be drilled, and both the brackets fixed to the wall using two screws (4mm x 30mm) and wall plugs for each.

NOTE: Fixing the chimney to wall plate is done at the end of installation.

7. The 2 x air flaps should be installed at this stage, as access is easier before the unit is wall mounted. On the top of the Hood Unit itself, where the air outlet vent is located, the 2 x flaps should be carefully installed, bending very slightly so the lugs at each end locate into the holes, enabling flaps to pivot upwards when the unit is in operation, opening up the outlet fully for the air to pass through. Please note – the small spindles/lugs at each end of each flap locate into the holes on the housing, not the grooves above them:

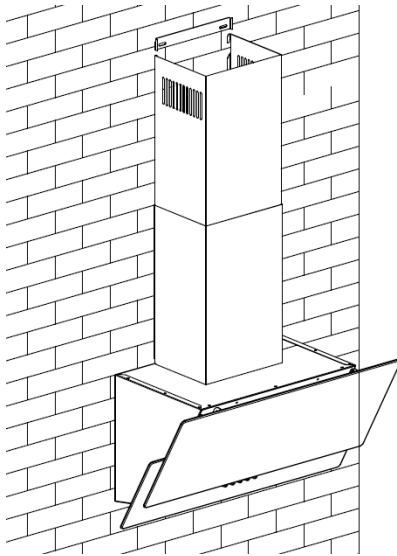
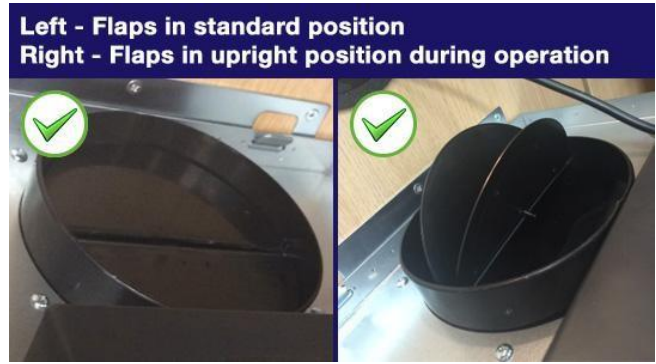

9. Put the chimneys back onto the cooker hood. Hook the outer chimney onto plate II. Lift up the inner chimney to the desired height and hook in onto plate I. Alternatively Plate I can be attached to the chimney using 2 x 10mm screws (Supplied).

10. Plug the power lead into the power socket (or if connecting directly to the mains via a switched spur, ensure the work is carried out by a competent, qualified person) and the cooker hood is then ready for use.

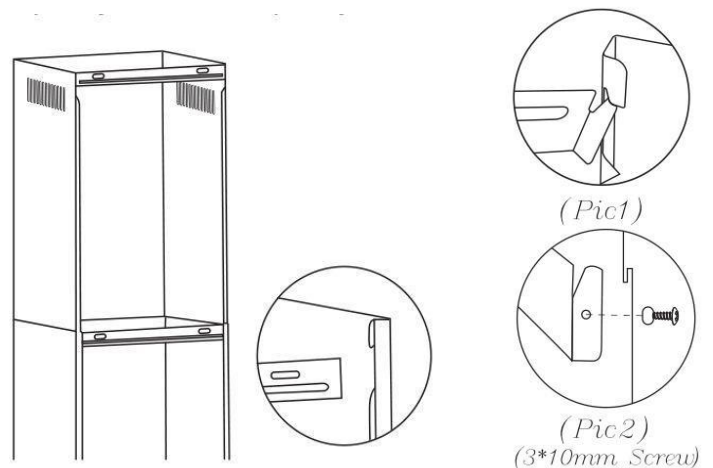

CARBON FILTER (Available separately)

Activated carbon filters can be used to trap odors, and must be used if the hood is not vented to the outside. They are available from the same stockist you purchased the hood from under the following reference:

eIQTMCARBONCHIM (Carbon Filter Pack of 2)

In order to install the activated carbon filter, the metallic anti-grease filter should first be detached. Press the lock and pull it downward.

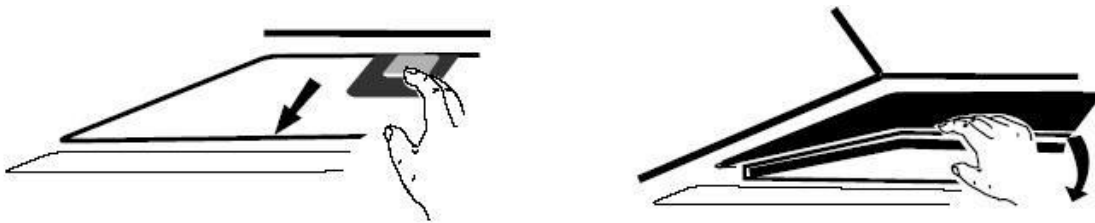

Put the activated carbon filter into the unit, fix it by turning them clockwise it at each end of the motor (see diagram below)

Repeat the same on the opposite side.

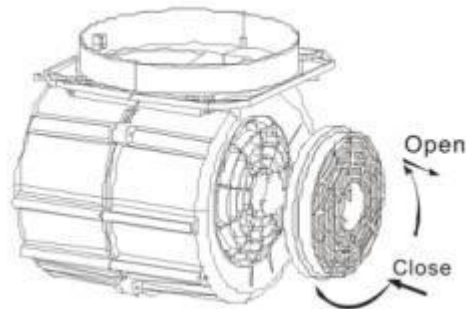

NOTE:

- Make sure the filter is securely locked. Otherwise, it could loosen and cause damage to the unit.
- When the activated carbon filters are attached, the suction power will be lowered.
- The charcoal filters cannot be washed or recycled. They should be changed at three or six months according to the amount of use the hood receives. Replacements are available from the stockist you purchased the hood from.

OPERATION

Operation of your hood is extremely simple. There are essentially 3 controls: Power On/Off; Fan Speeds (3 separate buttons) and Illumination.

Push buttons

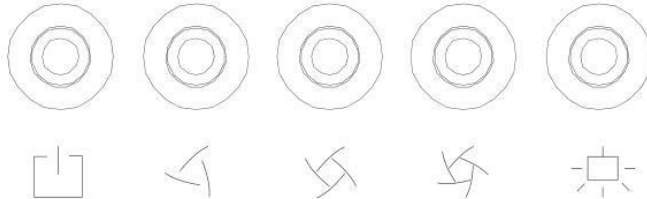

Off button

Used for turning off the fan.

Low Speed button

Starts the fan in low speed mode. It is suitable for simmering and cooking which do not make much steam.

Medium Speed button

Starts the fan at medium speed. This is ideal for ventilation during standard cooking operation.

High Speed button

Starts the fan in high speed. This is ideal for when a high density of smoke or steam has been produced.

Light button

Used for turning on/off the light.

MAINTENANCE

Before cleaning, switch the unit off and pull out the plug, or switch off at the relevant mains switch if the unit has been hard-wired. Make sure the unit has no power being fed to it.

REGULAR CLEANING

Use a soft cloth moistened with hand-warm mildly soapy water or household cleaning detergent. Never use metal pads, chemicals, abrasive material or a stiff brush to clean the unit.

NOTE: Do not use a steam-cleaner to clean the hood; electrical components could be damaged or short-circuit as a result.

MONTHLY CLEANING FOR METALLIC ANTI-GREASE FILTER

ESSENTIAL NOTE: Clean the filter every month; an excessive build-up of grease can become a fire hazard. The filter collects grease, smoke and dust, so the filter directly affects the efficiency of the cooker hood. If it's not cleaned, the grease residue (potentially flammable) will saturate on the filter.

Remove the filter as shown in the Installation section. Clean it with a soft nylon brush in a mild solution of warm water and a small amount of washing up liquid. Washing up liquid alone should not be used. After cleaning, allow the filter to drain and then dry thoroughly.

The grease filter may also be cleaned in a dishwasher using a 60°C program, with the filter upright (short sides upright) in the lower basket. Please be aware some dishwasher cleaning agents can permanently discolor the filter, though this will not affect its performance.

Replacement grease filters are available from the same stockist from which you purchased the hood under the following reference:

eiQTMGREASE4

REPLACEMENT FOR ACTIVATED CARBON FILTER

These are only required in units that have been installed in recirculation mode. This filter traps odours and must be replaced ideally every 3-6 months depending on how frequently the cooker hood has been used. They are not washable or reusable. Replacements are available from the retailer the hood was purchased from under reference: **eiQTMCARBONCHIM**

LIGHT BULB REPLACEMENT

Your cooker hood is supplied with 4 long life LED light fittings, although these are designed to have a very long lifespan, should one fail, replacements are available from the supplier of the hood and the guide below can be followed to replace it.

1. Switch the unit off and make sure it is disconnected from the mains supply.
2. Remove the aluminum grease filter
3. Pull out the LED light carefully, follow the wire from the fitting, and unplug at the connector.
4. Install the replacement fitting by feeding the connector through the unit, and plugging back in
5. The replacement bulb should then press into place.
6. The aluminum grease filter can then be refitted.

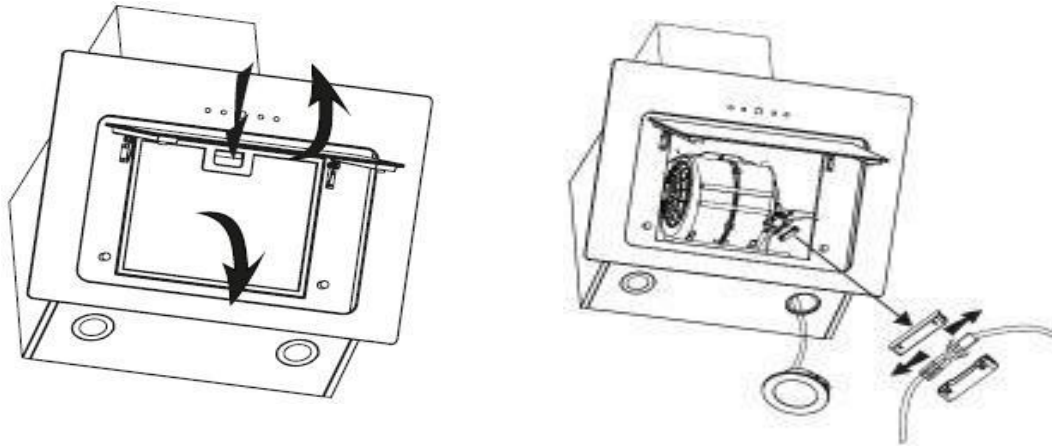

TROUBLESHOOTING

Fault	Cause	Solution
Light on, but fan does not work	The fan blade is jammed.	Switch off the unit. Repair to be carried out by qualified service personnel only.
	The motor is damaged.	
Both light and fan do not work	Halogen light bulb blown	Replace the bulb with correct rating.
	Power cord loose	Plug in to the power supply again.
Excessive Vibration	The fan blade is damaged.	Switch off the unit. Repair to be carried out by qualified service personnel only.
	The fan motor is not fixed tightly.	Switch off the unit. Repair to be carried out by qualified service personnel only.
	The unit is not hung properly on the bracket.	Take down the unit and check whether the bracket is in proper location.
Suction performance not good	<ol style="list-style-type: none"> 1 Grease filters clogged? 2 Distance between the unit and the cooking plane too great. 	<ol style="list-style-type: none"> 1 Clean or replace grease filters. 2 Adjust the distance to between 70cm and 80cm.

SPECIFICATION

	Symbol	Value	Unit
Model identification		eiQTMS60BL eiQTMS90BL eiQTMS60SS	
Annual Energy Consumption	AEC_{hood}	37.7	kWh/a
Time increase factor	f	1.7	
Fluid Dynamic Efficiency	FDE_{hood}	8.27	
Energy Efficiency Index	EEl_{hood}	77.9	
Measured airflow rate at the best efficiency	Q_{BEP}	155.78	m ³ /h
Measured air pressure at best efficiency point	P_{BEP}	109.32	Pa
Maximum airflow	Q_{max}	320	m ³ /h
Measured electric power input at best efficiency point	W_{BEP}	57.21	W
Nominal power of the lighting system	W_L	3	W
Average illumination of the lighting system on the cooking surface	E_{middle}	148.2	lux
Measured power consumption on standby mode	P_S	--	W
Measured power consumption on off mode	P_O	0	W
Sound power level	L_{WA}	60.48	dB

The following shows how to reduce total environmental impact (e.g. energy use) of the cooking process).

- (1) Install the cooker hood in a proper place where there is efficient ventilation.
- (2) Clean the cooker hood regularly so as not to block the airway.
- (3) Remember to switch off the cooker hood light after cooking.
- (4) Remember to switch off the cooker hood after cooking.

INFORMATION FOR DISMANTLING

Do not dismantle the appliance in a way which is not shown in the user manual. The appliance could not be dismantled by user. At the end of life, the appliance should not be disposed of with household waste. Check with your Local Authority or retailer for recycling advice.

INFORMATION FOR DISMANTLING

Do not dismantle the appliance in any way which is not shown in the user manual. The appliance must not be dismantled by an unqualified person. At the end of its life, the appliance should not be disposed of with general household waste. Check with your Local Authority or retailer for recycling advice.

electriQ UK SUPPORT

www.electriQ.co.uk/support

Call: 0333 043 6692

Office hours: 9AM - 5PM Monday to Friday

www.electriQ.co.uk

Unit J6, Lowfields Business Park
Lowfields Way, Elland
West Yorkshire, HX5 9DA



Recycling facilities are now available for all customers at which you can deposit your old electrical products. Customers will be able to take any old electrical equipment to participating sites run by their local councils. Please remember that this equipment will be further handled during the recycling process, so please be considerate when depositing your equipment. Please contact the local council for details of your local household waste recycling centers.