

electriciQ

USER MANUAL

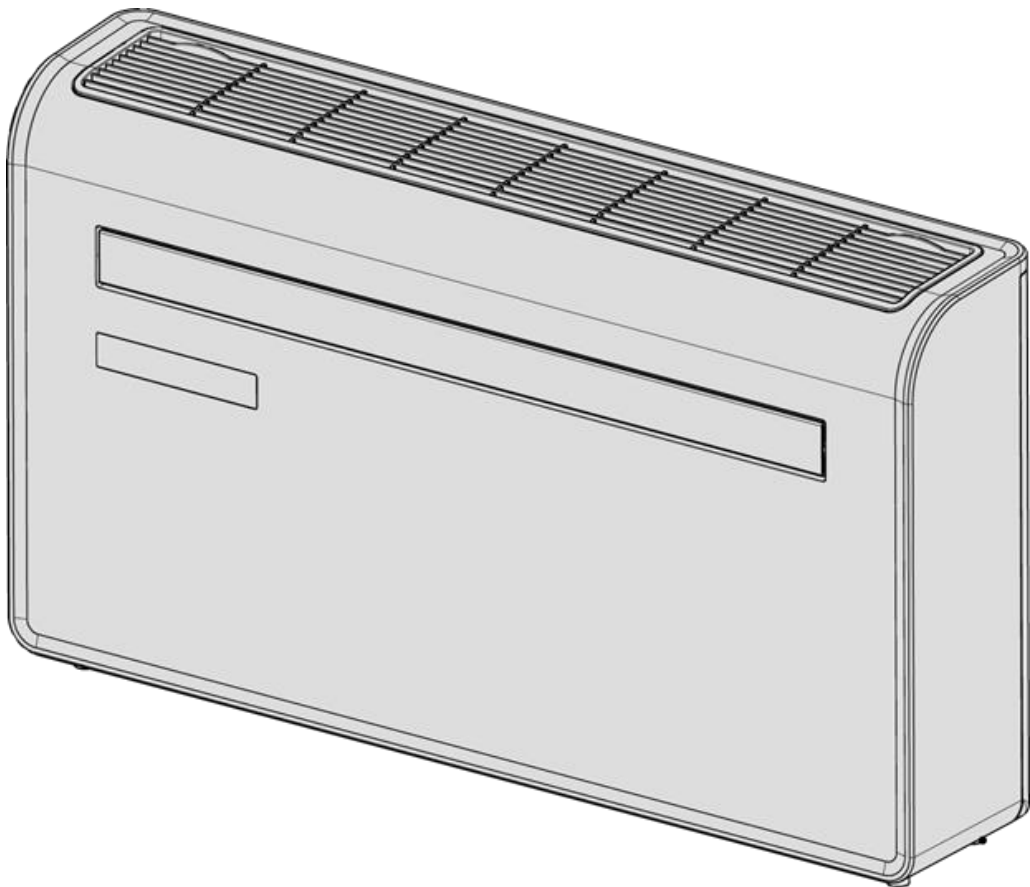

electriciQ WALL MOUNTED AIR CONDITIONER WITH HEAT PUMP AND WIFI SMART APP IQOOL-SMART12HP

Thank you for choosing electriciQ

Please read this user manual before using this innovative Air Conditioner and keep it safe for future reference.

Visit our page www.electriQ.co.uk for our entire range of Intelligent Electricals

CONTENTS

SAFETY INSTRUCTIONS	2
PRODUCT OVERVIEW	4
PRODUCT DIAGRAM	4
FEATURES	5
WHATS INCLUDED	5
INSTALLATION	6
TOOLS REQUIRED	6
INSTALLATION	7
OPERATION	10
CONTROL PANEL	10
REMOTE CONTROL	10
FUNCTIONS	10
WIFI SETUP AND SMART FEATURES	12
SETUP	12
CONTROLLING YOUR DEVICE THROUGH THE APP	17
SMART SCENES / AUTOMATION	19
TROUBLESHOOTING	22
TROUBLESHOOTING	22
ERROR CODES	23
TECHNICAL DATA	24
UK SUPPORT	25

SAFETY INSTRUCTIONS

IMPORTANT!

AIR CONDITIONERS MUST ALWAYS BE STORED AND TRANSPORTED UPRIGHT, OTHERWISE IRREPARABLE DAMAGE MAY BE CAUSED TO THE COMPRESSOR; IF IN DOUBT WE SUGGEST WAITING AT LEAST 24 HOURS FOLLOWING INSTALLTION BEFORE STARTING THE UNIT.



- Carefully read the instructions before installing and/or operating the unit
- This appliance is for indoor use only.
- This unit must be only connected to a 220-240 V / 50 Hz earthed outlet.
- Installation must be in accordance with regulations of the country where the unit is used.
- If you are in any doubt about the suitability of your electrical supply have it checked and, if necessary, modified by a qualified electrician.
- This air conditioner has been tested and is safe to use. However, as with any electrical appliance - use it with care.
- Disconnect the power from the appliance before dismantling, assembling or cleaning.
- Avoid touching any moving parts of the appliance.
- Never insert fingers, pencils or any other objects though the guard.
- This appliance is not intended for use by persons (including children) with reduced physical, sensory or mental capabilities. It is also not intended for use by those with a lack of experience and knowledge, unless they have been given supervision or instruction concerning the use of the appliance by a person responsible for their safety.
- Do not leave children unsupervised with this appliance.
- Do not clean the unit by spraying it or immersing it in water.
- Never connect the unit to an electrical outlet using an extension cord. If an outlet is not available, one should be installed by a qualified electrician.
- Do not operate the unit unless it has been fully installed following the guidance provided within this manual.
- Never operate this appliance if the cord or plug is damaged. Ensure the power cord is not stretched or exposed to sharp objects/edges.
- A damaged supply cord should be replaced by the manufacturer or a qualified electrician in order to avoid a hazard.
- Any service other than regular cleaning or filter replacement should be performed by an authorised service representative. Failure to comply could result in a voided warranty.
- Do not use the appliance for any purpose other than its intended use.
- Avoid restarting the air conditioner unless 3 minutes have passed since being turned off. This prevents damage to the compressor.
- Never use the mains plug as a switch to start and turn off the air conditioner. Use the provided ON/OFF button located on the control panel.
- The appliance should not be installed in laundry or wet rooms.
- The appliance must be installed in a room without sources of ignition (for example: open

flames, an operating gas appliance or an operating electric heater).

- The unit must be installed on a solid vertical wall by a competent person. The electricity supply must only be connected after installation is complete.
- R290 refrigerant gas complies with European environmental directives.
- R290 has a low GWP (Global Warming Potential) of 3.
- The air conditioner contains about 260 g of R290 refrigerant gas.
- Do not install or store in an unventilated space with an area smaller than 12.5m² per unit. The room must be such as to prevent stagnation of possible leaks of refrigerant gas as there could be a danger of fire or explosion hazard should the refrigerant come into contact with electric heaters, stoves or other sources of ignition.
- If the appliance is installed, used or stored in an unventilated room, the room must be such as to prevent stagnation of possible leaks of refrigerant gas as there could be a danger of fire or explosion should the refrigerant come into contact with electric heaters, stoves or other sources of ignition.
- Refrigerant gas may be odourless.
- Do not use the product and contact the retailer for advice, if damage has occurred to the unit which may have compromised the refrigerant system.
- Any repairs or maintenance must only be carried out on the unit by a suitably qualified engineer. Before opening and servicing the unit the authorized engineer must be in possession of a copy of the manufacturer's service manual and must follow the safety information contained within it to ensure all hazards are minimized.
- The refrigerant system should not be perforated or punctured.

Energy Saving and Unit Safety Protection Tips

- Do not cover or restrict the airflow from the outlet or inlet grills.
- Keep the filters clean. Under normal conditions, filters should only need cleaning once every three weeks (approximately). Since the filters remove airborne particles, more frequent cleaning maybe necessary, depending on the air quality.
- For the initial start-up set the fan speed to maximum and the thermostat to 4-5 degrees lower than the current temperature. After, set the fan switch to low and set the thermostat to your desired setting.
- To protect the unit, we recommend not using the cool mode when the ambient temperature is higher than 35°C.

NOTE: Some pictures and information may vary from the final product. This is due to continual product improvement.

PRODUCT OVERVIEW

PRODUCT DIAGRAM

FRONT

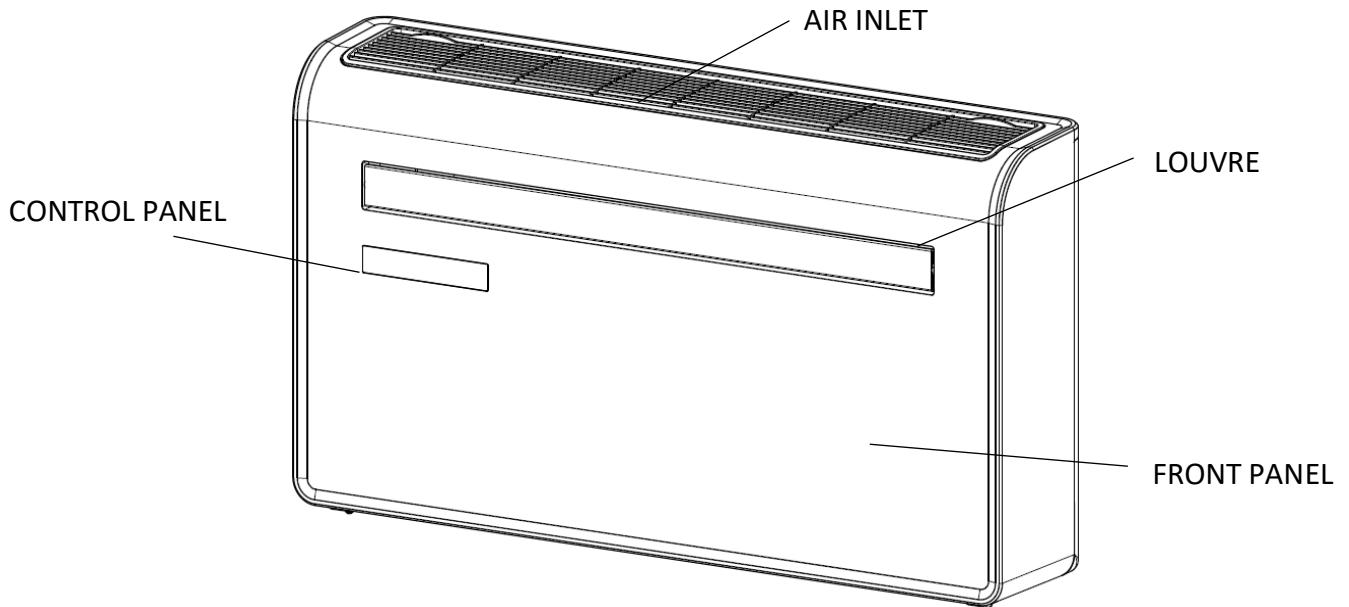

BACK

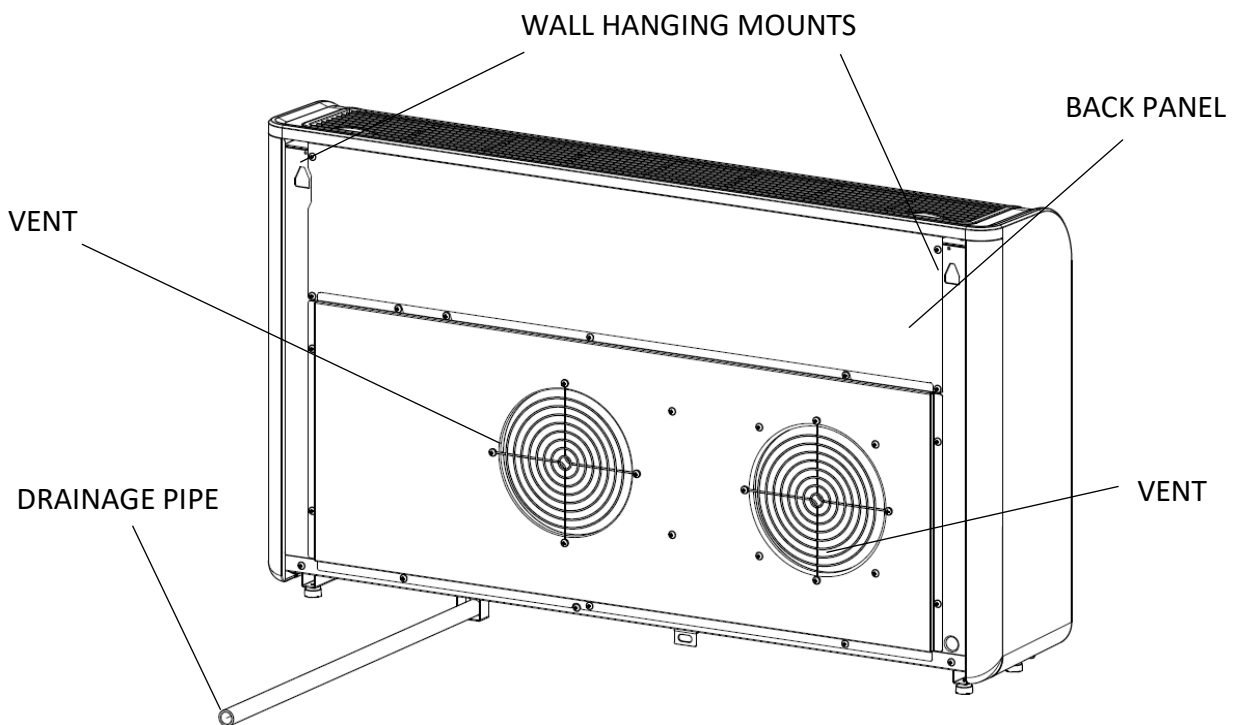

FEATURES

- Simple operation
- High and low installation options for added versatility
- Self-evaporative function with energy saving technology
- Sleek design that seamlessly fits into any style home
- Bright LED screen - Indicates temperature and current mode
- On/Off timer function - Allows you to choose when the unit operates
- WIFI App control providing additional functionality
- Three fan speeds
- Four modes to suit your every need including: Cooling/Heating/Fan/Dry.
- Silent running option, perfect for a restful night sleep

WHATS INCLUDED

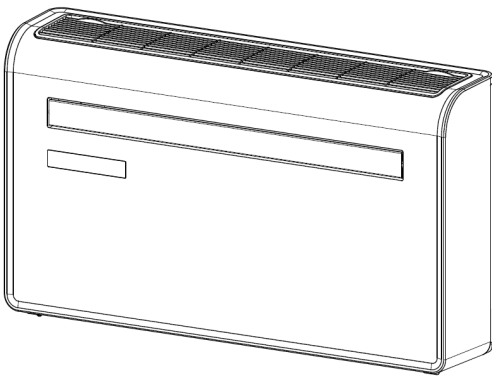

AIR CONDITIONER

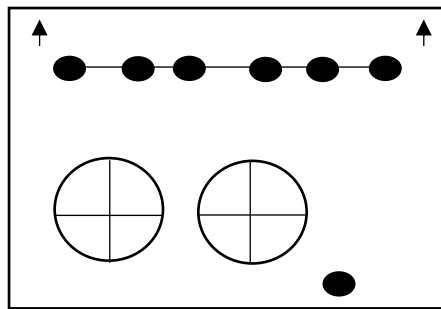

WALL TEMPLATE



SCREWS



WALL PLUGS

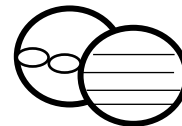

**VENT COVER ASSEMBLY (X2)
(CHAIN, INDOOR RING AND
OUTDOOR COVER)**

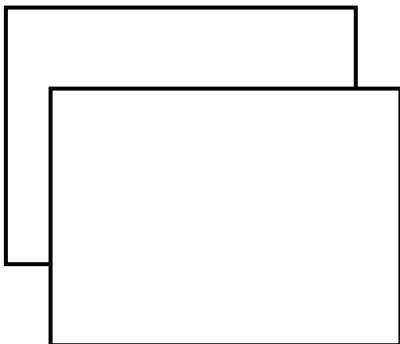

**PLASTIC DUCTING
SHEET (X2)**

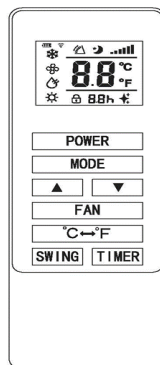

REMOTE CONTROL

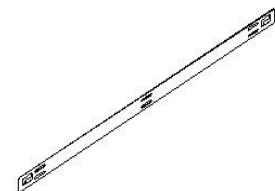

WALL BRACKET

DIAGRAMS FOR ILLUSTRATIVE PURPOSES ONLY

**WIRED CONTROLLER AVAILABLE SEPERATELY FROM THE RETAILER UNDER REFERENCE:
IQOOLSMART12HP-WiredCtrl**

INSTALLATION

TOOLS REQUIRED

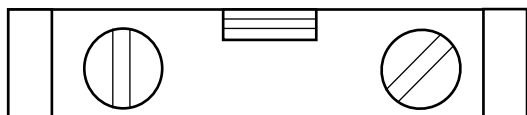

SPIRIT LEVEL

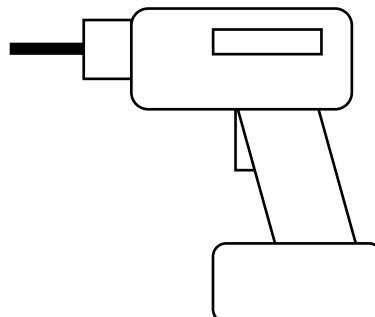

DRILL

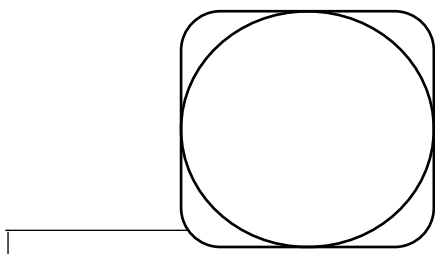

TAPE MEASURE

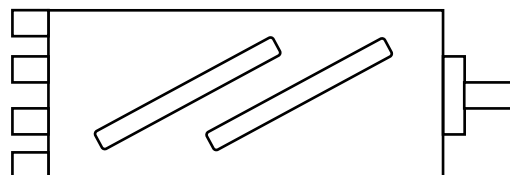

180 or 182mm CORE DRILL



8mm MASONRY DRILL BIT



20mm MASONRY DRILL BIT

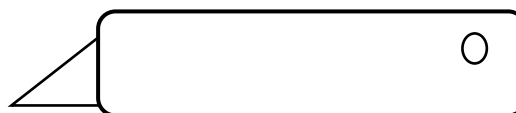

SHARP KNIFE

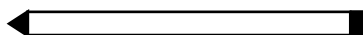

PENCIL

BEFORE STARTING INSTALLATION, PLEASE ENSURE YOU HAVE ALL SUITABLE EQUIPMENT AVAILABLE AND UNDERSTAND THE STEPS INVOLVED IN INSTALLATION. IF IN ANY DOUBT, PROFESSIONAL ADVICE SHOULD BE SOUGHT.

THE INSTALLER MUST ENSURE THAT THE PLANNED POSITION OF THE AIR CONDITIONER IS SUITABLE, AND THAT THERE ARE NO CABLES, PIPES OR OTHER OBSTRUCTIONS, WHICH WOULD PRESENT A DANGER AND/OR PREVENT COMPLETION OF INSTALLATION.

INSTALLATION

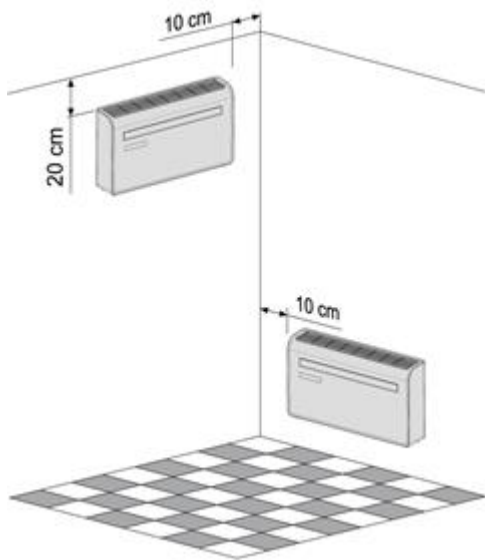

This unit must be installed on an external wall, as it vents directly out of its rear.

Only install the unit on a flat, solid and reliable wall. Ensure that there are no cables, pipes, steel bars or other obstructions behind the wall.

Leave at least 10 cm of space to the left and right of the machine. At least 20cm of space must be left above the unit to help air flow smoothly. The machine can be floor mounted if required.

Paste the supplied installation template paper in position on the wall, ensuring that the reference line is level using a spirit level.

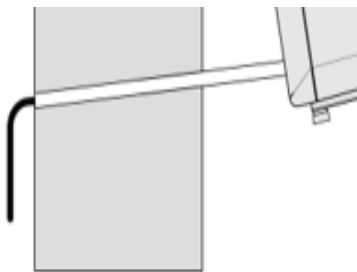
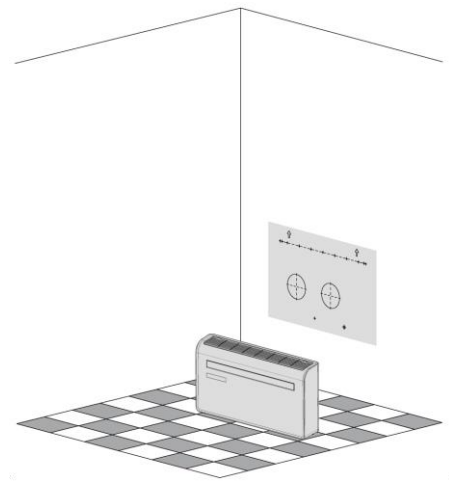

The hole for the drainage pipe must be drilled using a 20mm Drill bit. Ensure the hole is at a downward angle (min 5 degrees) so that the water will drain correctly

Use a 180 or 182mm core drill to drill the two holes for the units ventilation, ensuring that both the holes are aligned with the template.

Use the template to mark the position of the screws for the hanging rail, using a spirit level to ensure it is straight and level.

Drill the marked holes using a suitable 8mm drill bit and insert wall plugs. Line the hanging rail with the holes, and fix the rail into position using the supplied screws.

Ensure that the hanging rail is securely fastened onto the wall, and that there is no risk of the unit tipping or falling.

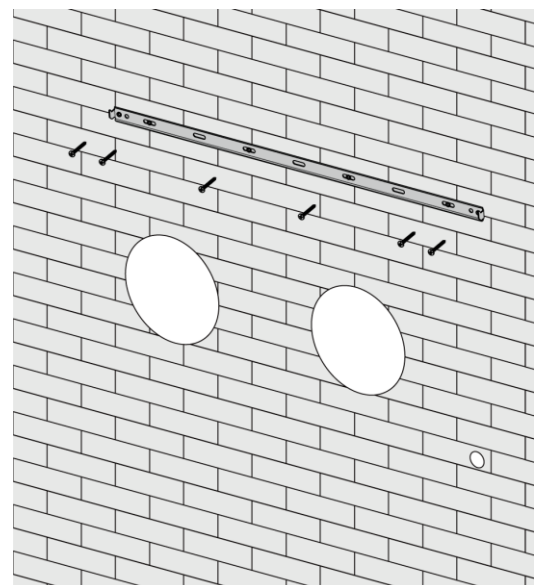

Roll the plastic vent sheets into a tube and feed them from the inside into the holes previously made. Ensure the tubes sit flush to the interior wall.

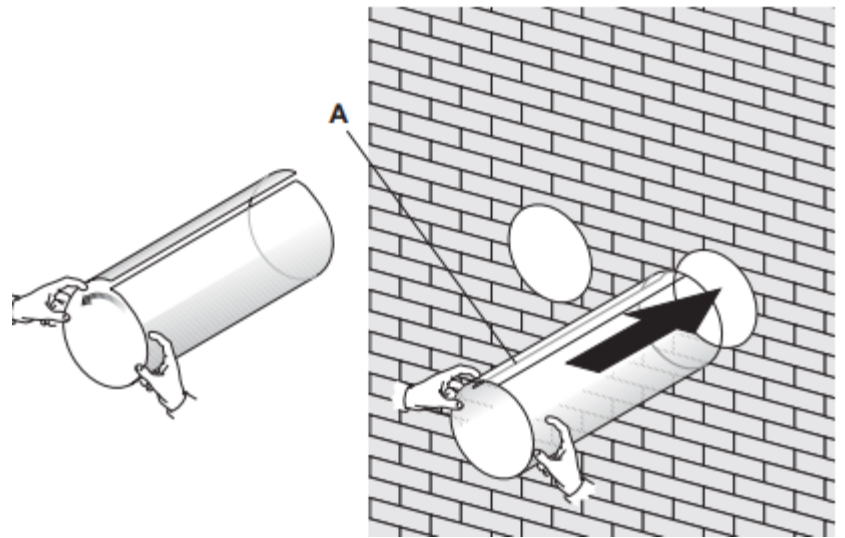
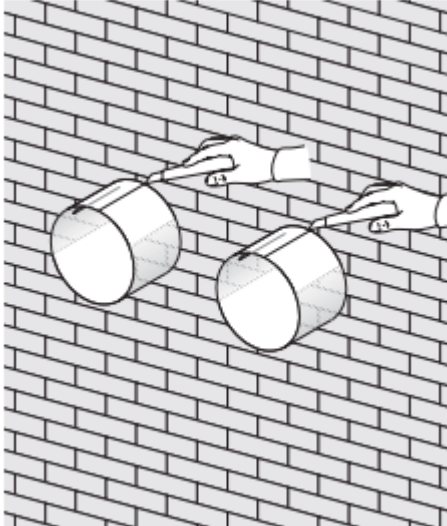

Go outside and trim off the excess vent tube using a sharp knife, keeping the edge as neat as possible.

Insert the indoor fixing ring from the vent cover onto the indoor side of the air vent. Then fold the external vent cover in half. Attach the chains to each side of the vent cover, before sliding the cover outside through the vent hole.

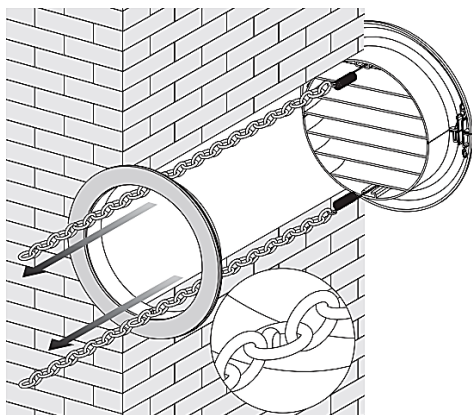
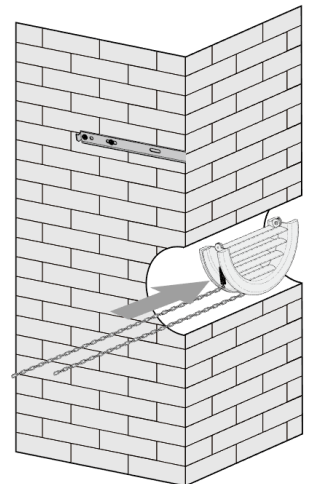
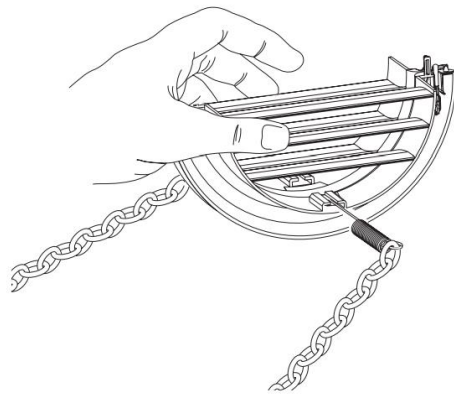

Expand the external cover, before tightly fixing the chains by hooking onto the indoor fixing ring. This will hold the external cover firmly in position. Repeat for the second vent.

Once the chains are fitted and secure, any excess chain should be removed by cutting the chain.

We would also advise running a bead of exterior caulk or similar around the external vent to help prevent water ingress.

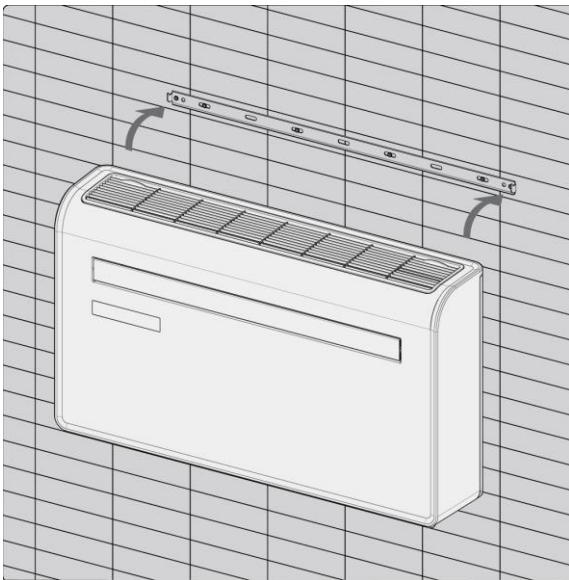
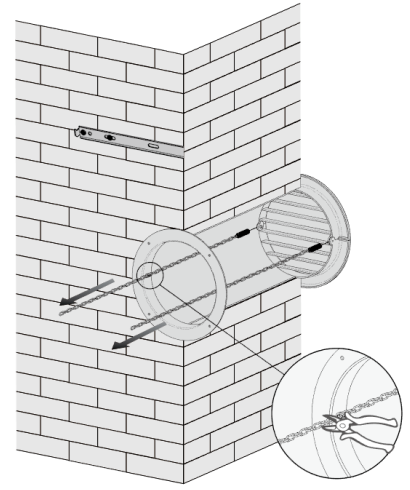

Lift the unit onto the wall, align the hanging holes with the hooks on the hanging rail and gently rest the unit into place. At the same time, slide the drain pipe through the drainage hole. If the wireless controller (Available separately) has been purchased, it should then be installed, and connected.

NOTE: The end of the external water pipe must be placed in an open space or drain. Avoid damage or constriction to the drainage pipe to ensure the unit drains.

OPERATION

CONTROL PANEL

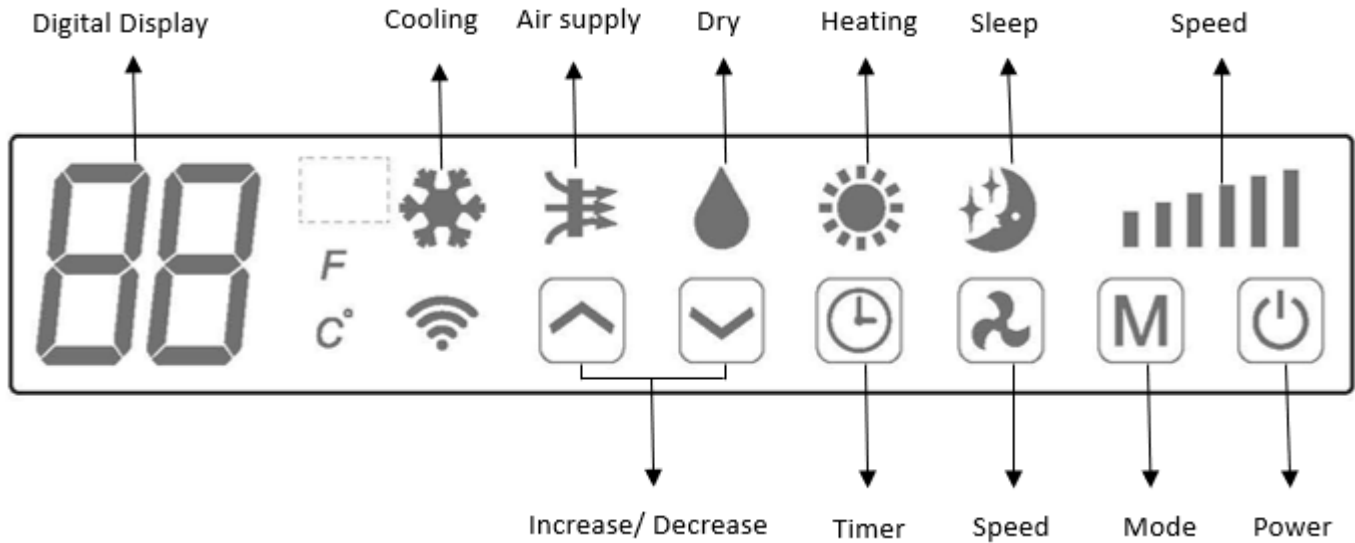

REMOTE CONTROL







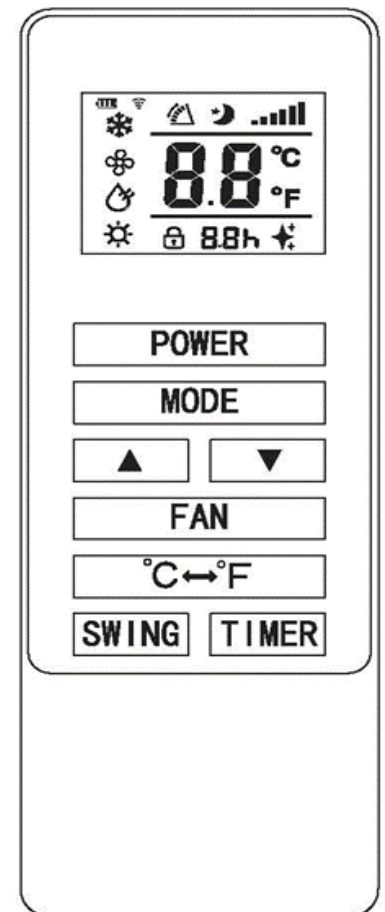



The air conditioner can be controlled with the remote control. Two AAA-batteries are required.

NOTE: Further details of the functions can be found on the following page.

POWER	Press the POWER button to turn the machine on or off.
TIMER	Press the TIMER button to set the timer.
▼	Press the DOWN button to decrease the desired temperature or timer duration
MODE	Press the MODE button to switch between cooling, heating, fan and dry modes.
▲	Press the UP button to increase the desired temperature or timer duration
FAN	Press the FAN button to change between high, medium and low fan speeds
SWING	Press to turn the swing function on and off (Can only be activated from the remote)
°C ↔ °F	Press to switch between displaying the temperature in fahrenheit and celcius.



FUNCTIONS

 POWER	Press "POWER" to turn the unit On or Off	
 MODE	Press to change between the 4 different modes. The display will show the symbol for the mode currently selected.	
	 COOLING	Cooling mode defaults to 22°C and will cool the air while sending warm air outside. The desired temperature can be adjusted using the increase and decrease button between 16°C and 30°C. The fan speed can also be adjusted using the speed button.
	 DRY	Dry mode will extract moisture from the air, which will be drained outside using the installed drain pipe. The fan speed cannot be adjusted in dry mode.
	 FAN	In fan mode the appliance will recirculate the air within the room, and will not cool or dehumidify. The fan speed can be adjusted using the Speed button.
	 HEATING	Heating mode defaults to 24°C and will heat the air while sending cool air outside. The desired temperature can be adjusted using the increase and decrease button between 16°C and 30°C. The fan speed can also be adjusted using the speed button.
	 SLEEP	Sleep mode can only be activated from the control panel by pressing the timer and up buttons at the same time. It will only operate in cooling or heating modes. In cooling mode, the fan speed will change to low, and the desired room temperature will increase by 1°C after 1 hour, and a second 1°C after 2 hours, reducing the amount of time the compressor operates. In heating mode it works exactly the same, but the desired temperature is decreased.
 FAN SPEED		Press to change the fan speed between Low, Medium and High. The fan speed cannot be adjusted in Dry or Sleep modes.
 TIMER	The air conditioner contains a 24 hour timer, which can be used to either set a delayed start, or a set period of operation. The timers cannot be combined, although the app can be used to program periods of operation.	
	SHUTDOWN TIMER: While the unit is running press the timer button, the display will flash "0" 5 times. After the 5 th flash, use the up and down buttons to adjust the duration in 1 hour increments between 1 to 24 hours. When the timer has elapsed, the unit will shutdown automatically.	
DELAYED START TIMER: With the unit in standby, press the timer button, the display will flash "0" 5 times. After the 5 th flash, use the up and down buttons to adjust the duration in 1 hour increments between 1 and 24 hours. After the timer has elapsed, the unit will start up in the same mode with the same settings as when it was turned off.		
 INCREASE AND DECREASE	Used within cooling and heating modes to adjust the desired room temperature. Also used while setting the timer to adjust the duration.	
SWING MODE	After machine turns on, press the "SWING" button, louver will swing continuously up and down; by pressing the button again the movement will stop and the louver remain in that position. Swing mode can only be adjusted from the remote, and will initially be turned on by default.	
COMPRESSOR PROTECTION	There is a 3 minutes delay on power on. In order to protect the life of the compressor and electronic components please do not switch on the unit for at least 5 minutes after you turned the unit off.	

WIFI SETUP AND SMART FEATURES

WIFI SETUP

BEFORE YOU START

- Ensure your router provides a standard 2.4ghz connection.
- If your router is dual band ensure that both networks have different network names (SSID). The provider of your router / Internet service provider will be able to provide advice specific to your router.
- Place the air conditioner as close as possible to the router during setup.
- Once the app has been installed on your phone, turn off the data connection, and ensure your phone is connected to your router via wifi.

DOWNLOAD THE APP TO YOUR PHONE

Download the "TUYA SMART" app, from your chosen app store, using the QR codes below, or by searching for the app in your chosen store.



Android



IOS

CONNECTION METHODS AVAILABLE FOR SETUP

The air conditioner has two different setup modes, Quick Connection and AP (Access Point). The quick connection is a quick and simple way to set the unit up. The AP connection uses a direct local wifi connection between your phone and the air conditioner to upload the network details.

Before starting the setup, with the air conditioner plugged in, but turned off, press and hold the Fan Speed button on the air conditioner for 5 seconds (until you hear a bleep) to enter the wifi connection mode. Please note the WIFI mode cannot be adjusted from the remote.

Please ensure your device is in the correct WIFI connection mode for the connection type you are attempting, the flashing of the WIFI light on your air conditioner will indicate this.

Connection Type	Frequency of Flashes
Quick Connection	Flashes twice per second
AP (Access Point)	Flashes once per three seconds

CHANGING BETWEEN CONNECTION TYPES

To change the unit between the two WIFI connection modes, hold the Fan Speed button on the air conditioner for 3 seconds.

REGISTER THE APP

1. Press on the register button at the bottom of the screen.

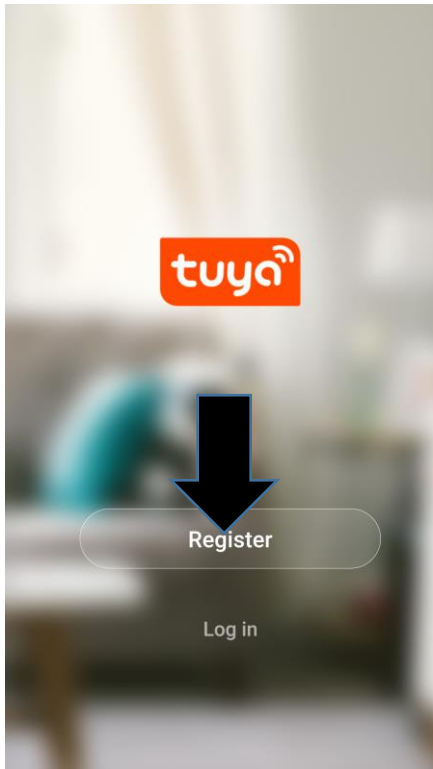

2. Read the Privacy policy and press the Agree Button.

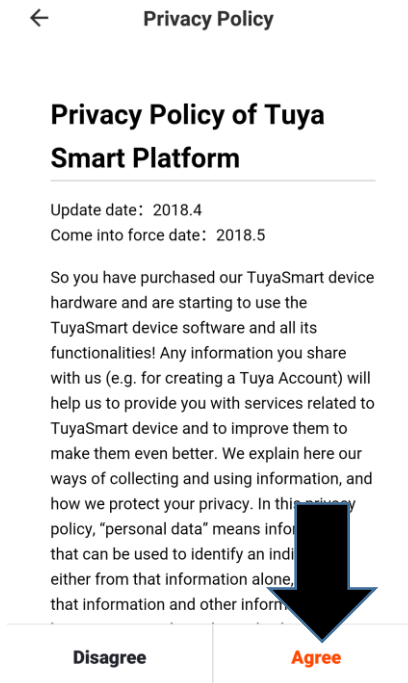

3. Enter your email address or phone number and press continue to register.

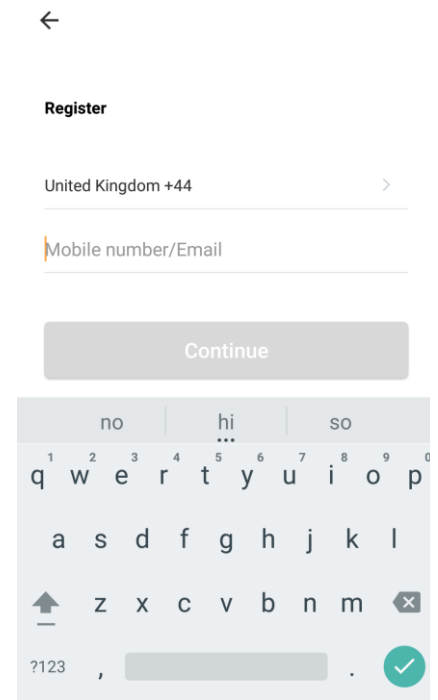

4. A verification code will be sent by the method selected in step 3. Enter the code into the app.

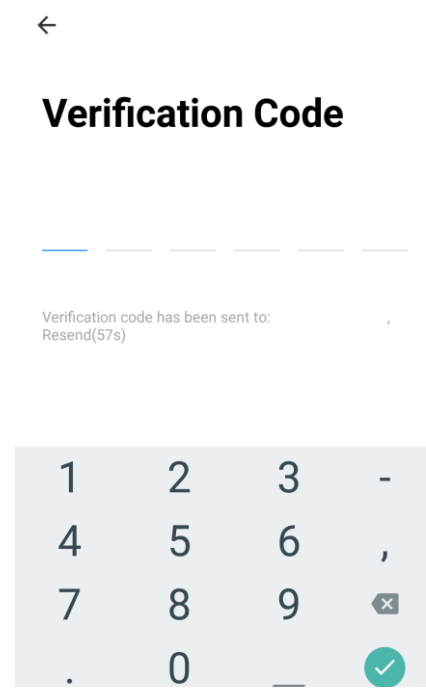

5. Type in the password you would like to create. This needs to be 6-20 characters, with letters and numbers.

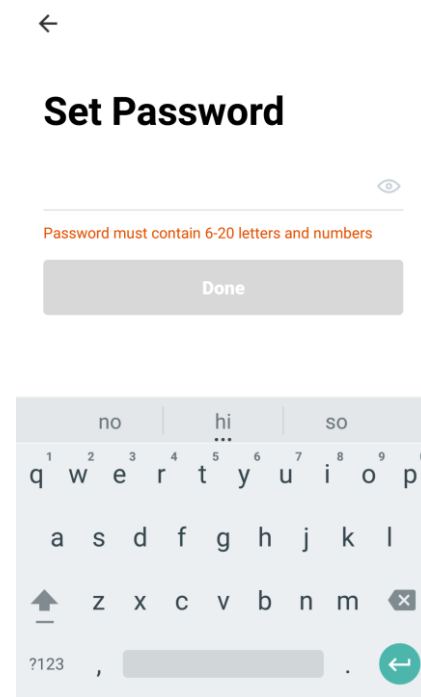

6. The app is now registered. It will automatically log you in following registration.

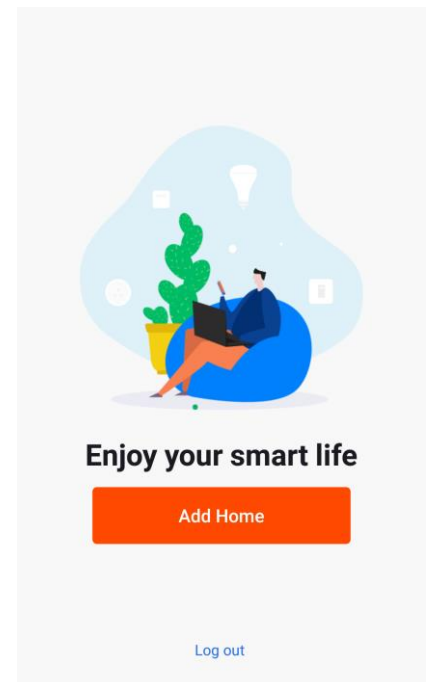

SETTING UP YOUR HOME WITHIN THE APP

TUYA is designed so it can work with a large number of compatible smart devices within your home. It can also be set up to work with multiple devices within different houses. As such during the setup process, the app requires that different areas are created and named to allow easy management of all your devices. When new devices are added, they are assigned to one of the rooms you have created.

CREATING ROOMS

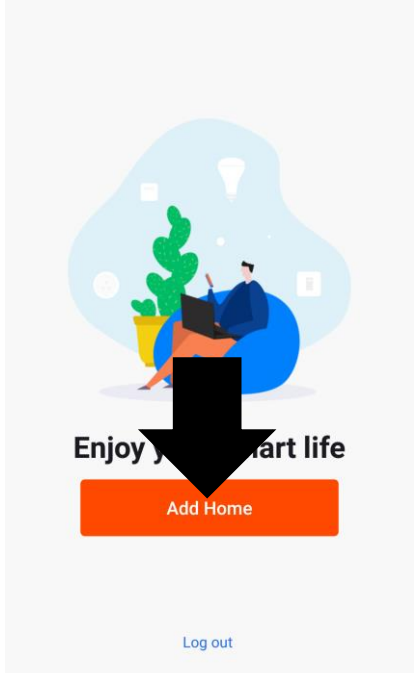
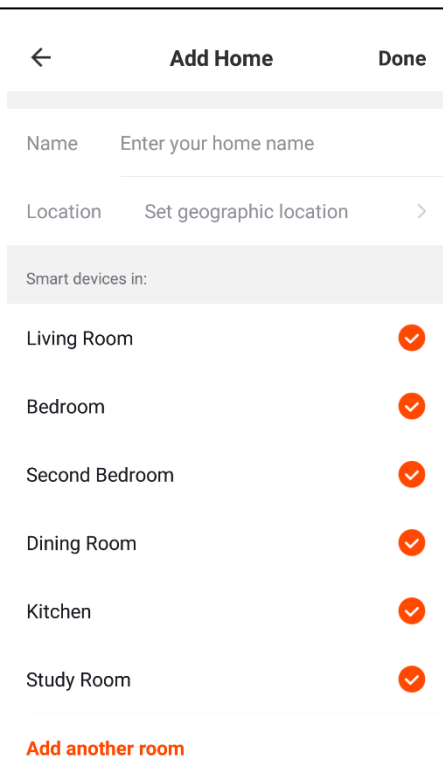
<p>1. Press on the ADD HOME button.</p> 	<p>2. Type in a name for your home, 3. Press on the location button to select the location of your home. (See SETTING YOUR LOCATION below) 4. New rooms can be added by pressing the ADD ANOTHER ROOM option at the bottom. (See ADD ANOTHER ROOM below) 5. Untick any rooms that are not required on the app. 6. Press DONE in the top right corner.</p>	
--	---	---

SETTING YOUR LOCATION

Use your finger to move the orange HOME symbol.

When the symbol is in the approximate location of your home, press the confirm button in the top right corner.

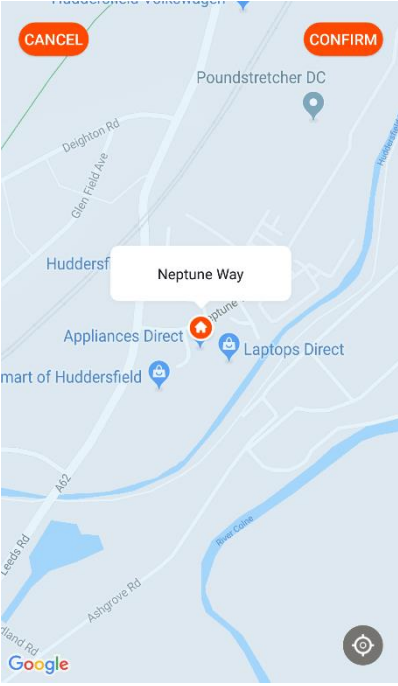

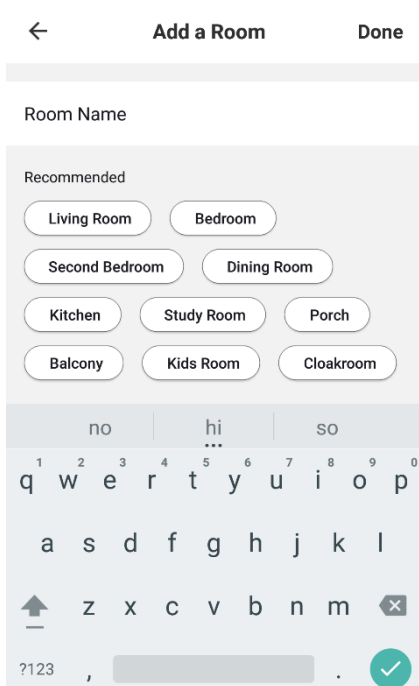

ADD ANOTHER ROOM

Type in the name of the room, and press Done in the top right corner

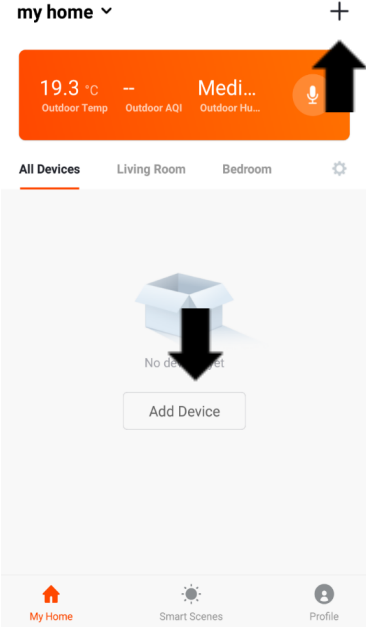

CONNECTING USING QUICK CONNECTION

Before initiating the connection, make sure the unit is in standby mode, with the WIFI light flashing twice per second. If not follow the instructions for changing the connection mode. Also ensure your phone is connected to the WIFI network. (We advise turning mobile data off during setup)

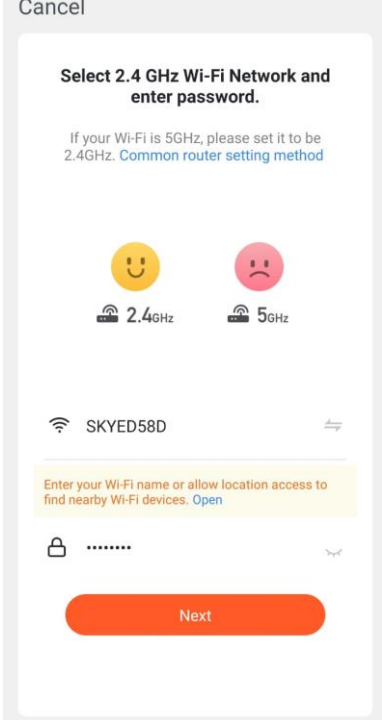
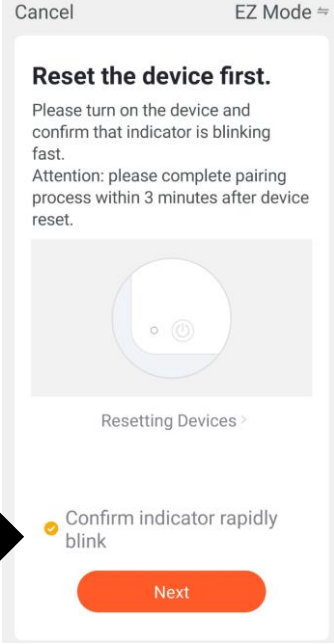
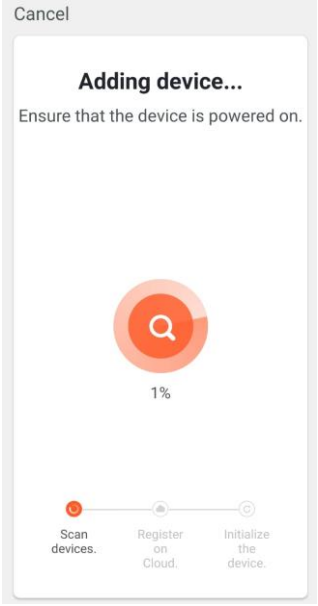
<p>1. Open app and press “+” to add device, or use the add device button</p> 	<p>2. Select the type of device as “Air Conditioner” in the “Small Home Appliance” tab.</p> 	<p>3. Ensure the correct network is shown and that the password is correct before pressing next.</p> 
<p>4. Ensure the WIFI light on the air conditioner is flashing twice per second, tick the box to confirm the speed of flashing and press Next.</p> 	<p>5. This will then transfer the settings to the air conditioner. Wait for this to complete. If this fails, retry. If still unsuccessful please review the troubleshooting section for further help.</p> 	

CONNECTING USING AP MODE (ALTERNATIVE METHOD)

Before initiating the connection, make sure the unit is in standby mode, with the WIFI light flashing once per second. If not follow the instructions for changing the WIFI connection mode. Also ensure your phone is connected to the WIFI network. (We advise turning mobile data off during setup)

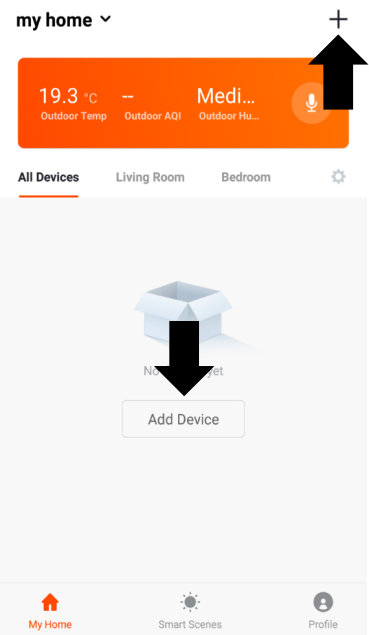
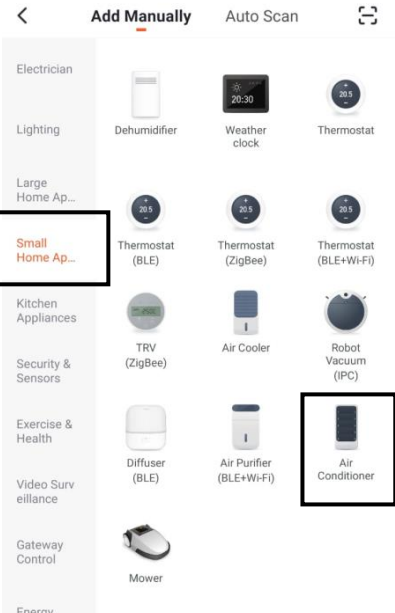
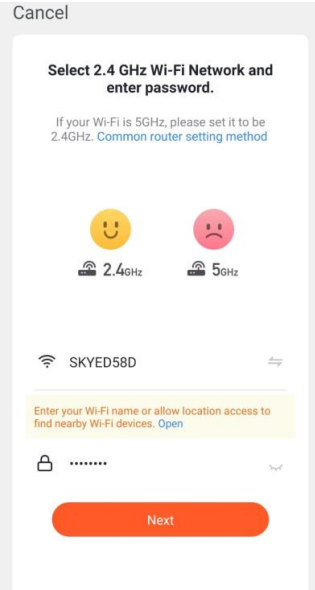
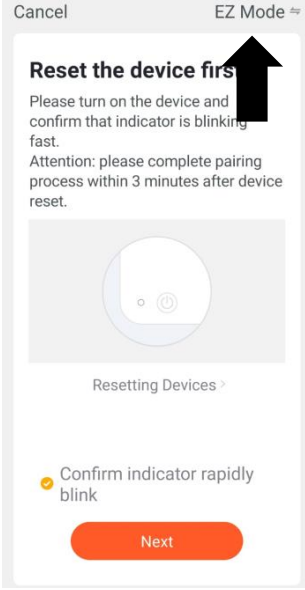
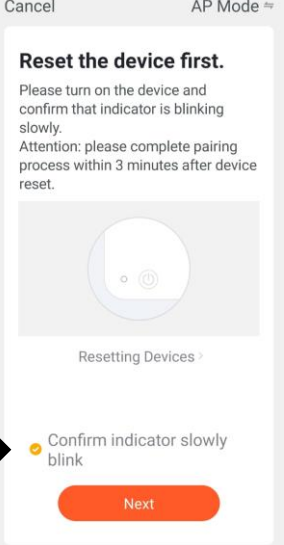
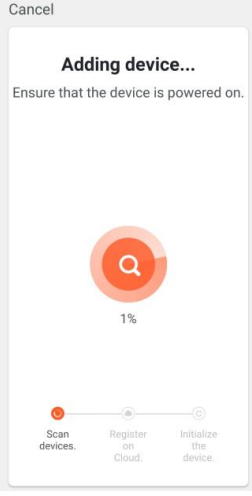
<p>1. Open app and press “+” to add device, or use the add device button</p> 	<p>2. Select the type of device as “Air Conditioner” in the “Small Home Appliance” tab.</p> 	<p>3. Ensure the correct network is shown and that the password is correct before pressing next.</p> 
<p>4. Press on the EZ mode button in the top right of the screen, and use the drop down menu to select AP Mode.</p> 	<p>5. Ensure the WIFI light on the air conditioner is slowly flashing, tick the box to confirm the speed of flashing and press Next.</p> 	<p>6. This will then transfer the settings to the air conditioner. Wait for this to complete. If this fails, retry. If still unsuccessful please review the troubleshooting section for further help.</p> 
<p>Once the connection process has completed, go back to the network settings on your phone to ensure your phone has reconnected to your WIFI router.</p>		

CONTROLLING YOUR DEVICE THROUGH THE APP

THE HOME SCREEN

Change Home: If you have a number of units at different houses, you can change between them

Environmental information: Provides outdoor temperature and humidity based on the location details entered

Rooms: Use to view the units set up within each room

Smart Scene: Allows you to program intelligent behaviour based on the internal and external environment

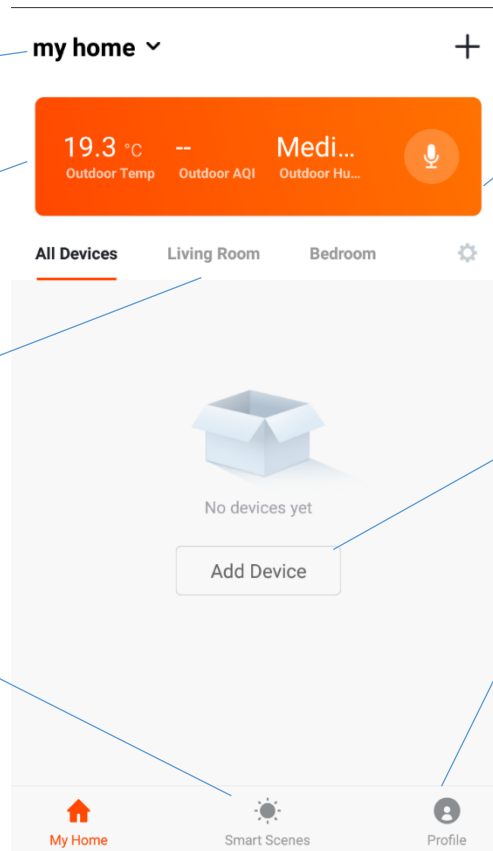

Add Device: Add a device to the app, and go through the setup process.

Room Management: Allows rooms to be added, removed or renamed.

Add Device: Add a device to the app, and go through the setup process.

Profile: Provides the option for changing settings, and adding devices using a QR code provided by a friend.

Each device has its own entry on the home screen to allow the user to either quickly turn the unit on or off, or to enter the device screen to make other changes.

DEVICE SCREEN

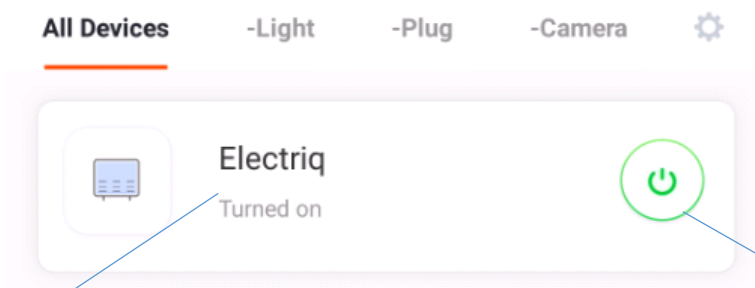

Name of Air Conditioner: Press to enter the Device Screen

ON / OFF Button: Use to quickly turn the unit on or off.

DEVICE SCREEN

The device screen is the main control screen for the air conditioner, providing access to the controls to amend the functions and settings

Back: Returns to the Home Screen

Current Room Temperature: Displays the current room temperature

Desired Temperature Down Button: Use to decrease the desired temperature

MODE:
Change the operating mode of the air conditioner between Cooling, Heating, Dehumidify and Fan

SPEED:
Use to change the Fan speed between Low, Medium and High. Note this cannot be changed in dehumidify mode.

Desired Temperature UP Button: Use to increase the desired temperature.

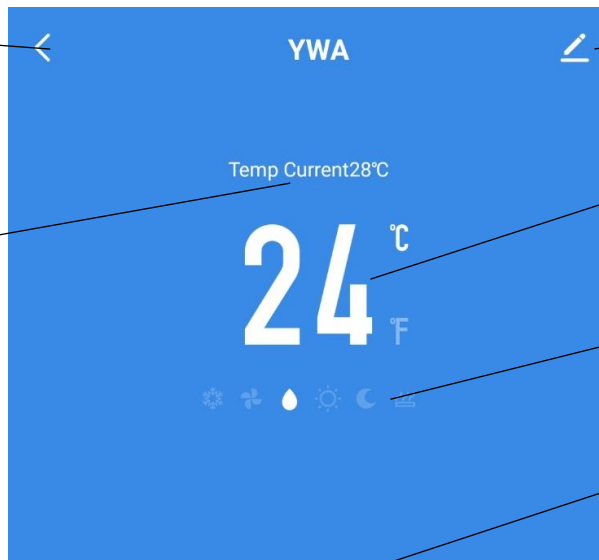

Edit Name: Use to change the name of the air conditioner.

Desired Room Temperature: Displays the desired room temperature

Current Mode: Shows the mode the air conditioner is currently in.

SWING:
Use to turn the oscillating swing function on and off.

SCHEDULE:
Use to add a set a scheduled operation. A number of these can be combined to specify automatic operation

TIMER:
Use to add an off timer while the unit is running, or an on timer while the unit is turned off

Desired Temperature UP Button: Use to increase the desired temperature.

ON / OFF Button: Use to turn the unit on or off.

*Due to continuous development of the app, the layout and available features may be subject to change.

SMART SCENES

Smart Scenes is a powerful tool providing the option to customise the operation of the air conditioner based both on conditions within the room and outside influences. This gives the user the option of specifying much more intelligent actions. These are split into two categories Scene and Automation.

SCENE

Scene allows for a one touch button to be added to the Home screen. The button can be used to change a number of settings in one go, and can change all the settings within the unit. A number of scenes can easily be setup, allowing the user to easily change between a number of preset configurations.

Below is an example of how to set up a scene:

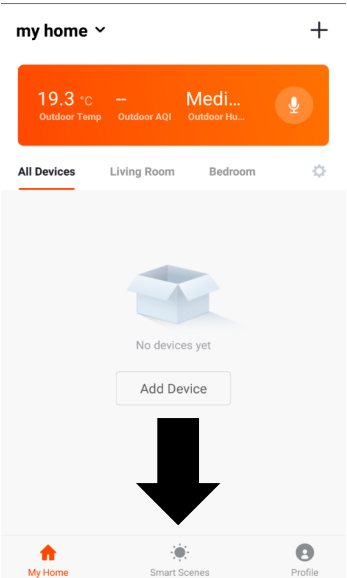
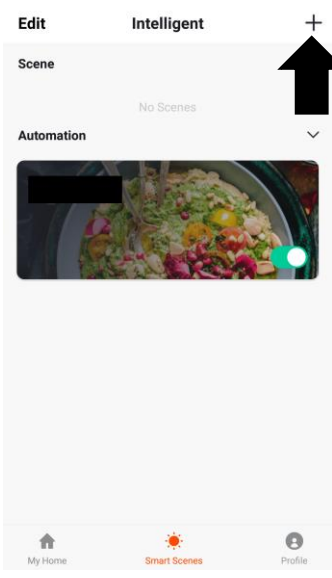
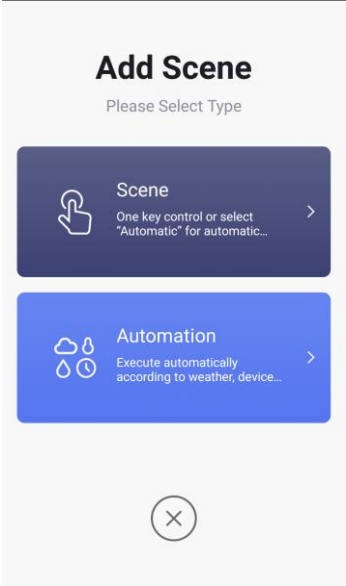
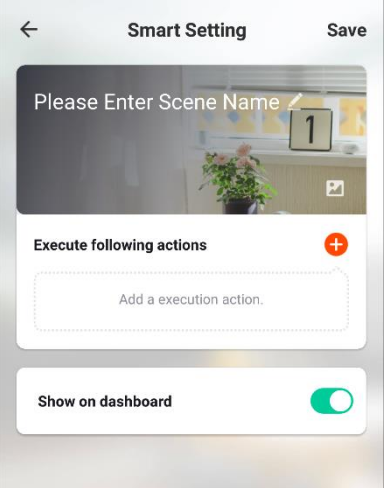
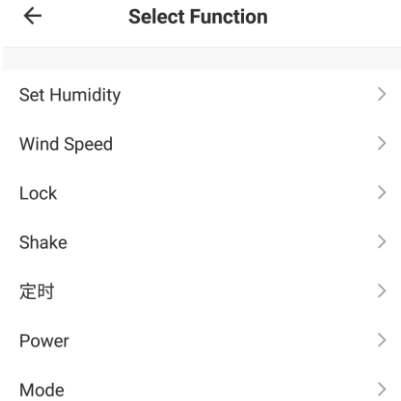
<p>1. Press on the Smart Scene tab at the bottom of the Home screen</p> 	<p>2. Press on the Plus in the top right corner to add a smart scene.</p> 	<p>3. Select Scene to create a new Scene</p> 
	<p>4. Press the Pen next to "Please Enter Scene Name" to input the name for your Scene</p> <p>Show on Dashboard: Leave this on if you require the scene to be displayed as a button on the Home Screen</p> <p>Press the Red Plus to add the action required. Then select the air conditioner from the list of devices.</p>	<p>5. Chose the function, set the value for the function, and then press the back button in the top right corner, to return to the previous screen.</p> 
<p>6. Once all the functions required have been added, press the Save button in the top right corner to finalise and save your new Scene</p>		

AUTOMATION

Automation allows an automatic action to be set up for the device. This can be triggered by the Time, indoor temperature, humidity of the room, weather conditions, and a range of other influences.

1. Press on the Smart Scene tab at the bottom of the Home screen

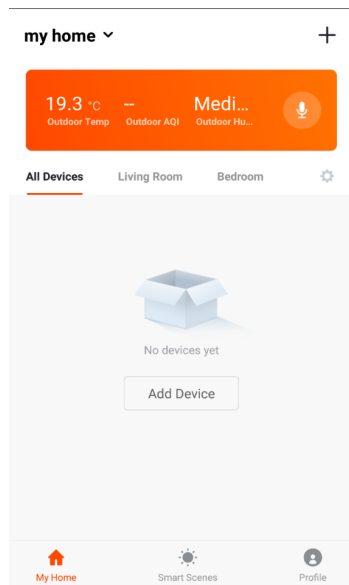

2. Press on the Plus in the top right corner to add a smart scene.

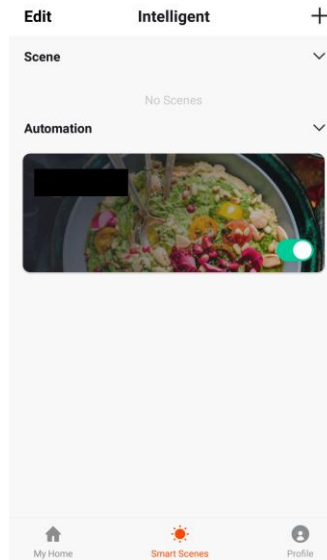

3. Select Automation to create a new Automation Scene

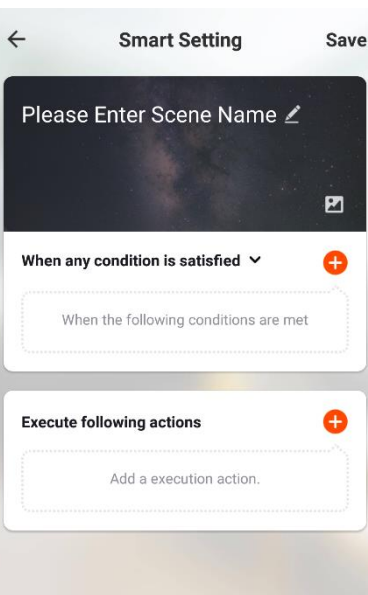
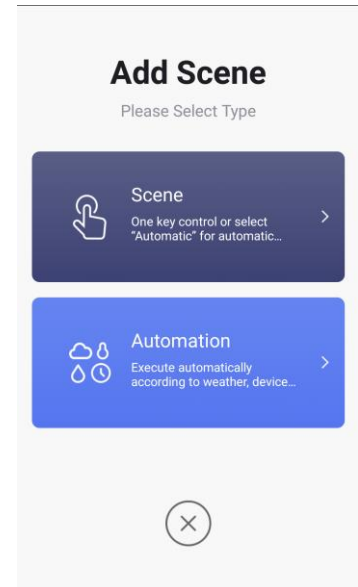

4. Setup is very similar to the scene setup on the previous page, and includes an extra section for specifying a trigger for the scene to start.

Press the Pen next to "Please Enter Scene Name" to input the name for your Scene

Press the Red Plus next to "When any condition is satisfied" to add the trigger

Press the Red Plus next to "Execute following actions" to add the action required. Then select the air conditioner from the list of devices.

5. Select the condition when the automation should start. A number of triggers can be combined.

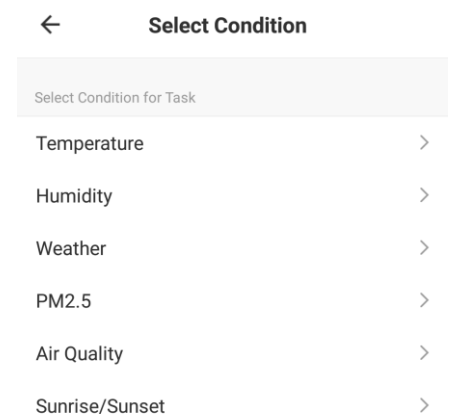

6. Chose the function, set the value for the function, and then press the back button in the top right corner, to return to the previous screen.

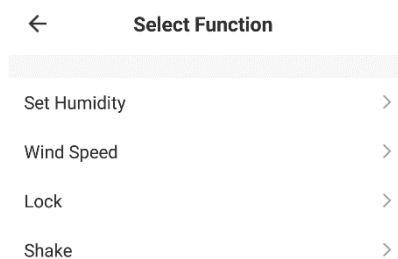

7. Once all the functions required have been added, press the Save button in the top right corner to finalise and save your new scene.

The automation is now set up, it can be turned on and off using the toggle on the image shown on step 2.

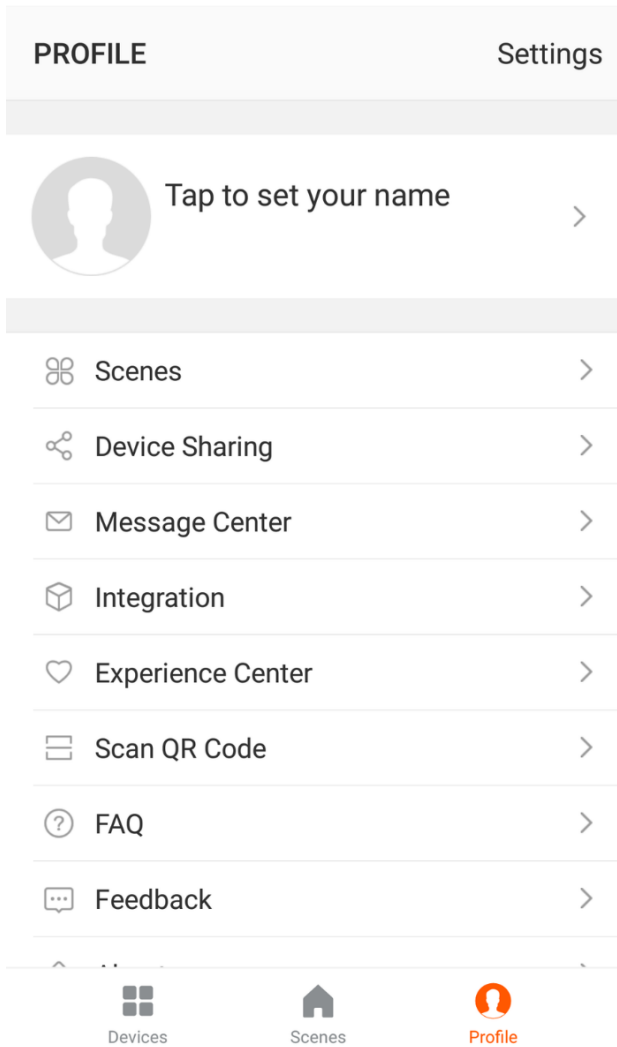

PROFILE TAB

The profile tab gives you the option to edit both your detail, and use the added features of the unit.

CHANGING THE NAME OF YOUR DEVICE

When in any of the device screens further settings for the device can be accessed, by pressing on the three dots in the top right hand corner. The top option within this allows you to change the name of the device to something relevant to the use of the product, such as “Living Room Air Conditioner”. Within the menu, you also have the option of setting up a pattern lock or change your password.

DEVICE SHARING

This allows you to share access to the controls of your air conditioner with friends and family.

INTEGRATION

This allows the unit to be integrated with your favourite home automation hardware such as Google Home and the Amazon Echo.

CONNECTION TROUBLESHOOTING

1. Check whether the device is powered on and is in the correct WIFI connection mode, if not please refer to the CHANGING BETWEEN CONNECTION MODES section on page 12.
2. Ensure the WIFI password has been entered into the app correctly (Case sensitive)
3. Check that the phone is connected to the WIFI you are connecting the device to.
4. Ensure the network you are connecting it to is 2.4Ghz (5Ghz WIFI networks are not supported), and that there is a strong WIFI signal to the item.
5. If your router is dual band, ensure that the 2.4ghz network has a different network name (SSID). Further advice on changing router settings will be available from your Internet service provider / Router manufacturer.
6. Check the settings on the router. Encryption should be WPA2-PSK and authorisation type should be set to AES
7. Try using the alternative connection method. i.e. If connection is failing when attempting to connect through CF mode, try AP mode.

TROUBLESHOOTING

Do not repair or disassemble the air conditioning. Unqualified repair will invalidate the warranty and may lead to failure, causing injuries and property damage. Only use it as directed in this user manual and only perform operations advised here.

Problem	Reasons	Solutions
The air conditioner does not work.	There is no electricity.	Check the unit is plugged in, and the socket is working normally.
	The ambient temperature is too low or too high	Only use to use the machine with a room temperature between 7 and 35°C
	In cooling mode, the room temperature is lower than the desired temperature; in heating mode, the room temperature is higher than the desired temperature.	Adjust the desired room temperaure
	In dehumidification (dry) mode, the ambient temperature is low.	Ensure that the room temperature is above 17°C for dry mode.
	There is direct sunlight.	Use curtains to reduce heat from the sun
The cooling or heating effect is poor	Doors or windows are open; there are a lot of people; or in cooling mode, there are other sources of heat (e.g. fridges)	Close doors and windows; increase air conditioning power
	The filters screen is dirty.	Clean or replace the filter screen.
	The air inlet or outlet is blocked.	Clear obstructions; make sure the unit is installed as per the instructions
The air conditioner is leaking	The unit is not straight	Use a spirit level to check the unit is horizontal, if not remove from the wall and straighen
	The drain pipe is blocked	Check the drain pipe to ensure it is not blocked or constricted.
Compressor does not work.	Overheat protection operational	Wait for 3 minutes until the temperature is lowered, and then restart the machine.
The remote control does not work.	The distance between the machine and the remote control is too far.	Let the remote control get close to the air conditioner, and make sure that the remote control directly faces to the direction of the remote-control receiver.
	The remote control is not aligned with the direction of the remote-control receiver.	
	Batteries are dead.	Replace batteries.

If problems not listed in the table occur or recommended solutions do not work, please contact the service centre.

ERROR CODES

Fault Code	Fault Description	Fault Code	Fault Description
F1	Compressor IPM error	FE	EE error (condenser circuit)
F2	PFC/IPM error	PA	Return air sensor temperature abnormal protection
F3	Compressor start error	P1	Over-heat protection on top of compressor
F4	Compressor running out of step	PE	Abnormal refrigerant circulation
F5	Location detection loop failure	PH	Exhaust temperature protection
FA	Phase current overcurrent protection	PC	Coil tube overload protection (condenser circuit)
P2	Dc bus voltage Undervoltage protection	E3	DC fan Feedback failure (evaporator circuit)
E4	Communication error (evaporator circuit and condenser circuit)	P6	Coil tube overload protection (evaporator circuit)
F6	PCB communication error	P7	Defrost protection on coil tube (evaporator circuit)
P3	AC Input voltage protection	E2	Sensor error on indoor coil tube
P4	AC over-current protection	E1	Temperature sensor error (evaporator circuit)
P5	AC undervoltage protection	P8	Zero-crossing fault detection (evaporator circuit)
F7	Coil sensor error(condenser circuit)	EE	EE error (evaporator circuit)
F8	Sensor on suction pipe error	E5	Water-splash motor error
E0	Sensor on discharge pipe error	E8	Fan feedback fault
E6	Temperature sensor error (condenser circuit)	FL	Water-full protection
E7	Fan motor error (condenser circuit)		

TECHNICAL DATA

MODEL	IQOOL-SMART12HP
Capacity Cooling/Heating	2.93 / 2.35KW
Rated Input Cooling / Heating	1120W / 745 W
Running Current Cooling/Heating	6.0A
Air Flow	500 m ³ /h
EER rate	2.6
Compressor	Rotary, 260g R290 gas
Noise	58dB (A)
Thermostat	16 - 30°C
Moisture removal	24 litres/day
Permitted Excessive Operating Pressure	0.8/2.8MPa
Maximum Allowable Pressure	1.3/3.8MPa
Power Supply	220-240V / 50Hz
Net Weight	38Kg
Dimension(L*D*H)	1000 x 205 x 585
<p>Unit must be vented outside when in Air Cooling and Heating mode. For the purposes of EU regulation EN12102 this is a local air conditioner and produces less than 65dB(A) sound energy.</p> <div style="text-align: center;">  <p>R290</p> </div>	

UK SUPPORT

electriQ UK SUPPORT

www.electriQ.co.uk/support

Please, for your own convenience, make these simple checks before calling the service line.

1. Has the unit been standing upright for at least 2 hours?
2. Is the unit plugged into the mains?
3. Is the fuse OK?
4. Switch the unit off and wait three minutes to see if the issue is resolved. Restart the unit.
5. Check if the water tank is full.
6. Was the troubleshooting guide followed?

If the unit still fails to operate call: 0330 390 3061 or complete the online form

Office hours: 9AM - 5PM Monday to Friday

Unit J6, Lowfields Business Park,
Lowfields Way, Elland
West Yorkshire, HX5 9DA

DECLARATION OF CONFORMITY

Hereby, electriQ declares that this Portable air conditioner is in compliance with Directive 2014/53/EU. The full text of the EU declaration of conformity is available at the following internet address:

<https://www.electriQ.co.uk/content/declaration-of-conformity>

Disposal: Do not dispose this product as unsorted municipal waste. Collection of such waste must be handled separately as special treatment is necessary.



Recycling facilities are now available for all customers at which you can deposit your old electrical products. Customers will be able to take any old electrical equipment to participating civic amenity sites run by their local councils. Please remember that this equipment will be further handled during the recycling process, so please be considerate when depositing your equipment. Please contact the local council for details of your local household waste recycling centres.