

Hotpoint



Use and Care Guide



www.hotpoint.eu/register



ENGLISH 4

ENGLISH

HEALTH & SAFETY, USE & CARE AND INSTALLATION GUIDE



THANK YOU FOR PURCHASING AN HOTPOINT PRODUCT

To receive more comprehensive help and support, please register your product at
www.hotpoint.eu/register

Index

Health and Safety guide

SAFETY INSTRUCTIONS4

SAFEGUARDING THE ENVIRONMENT6

DECLARATION OF CONFORMITY6

Use and Care Guide

PRODUCT DESCRIPTION7

CONTROL PANEL7

DESCRIPTION OF DISPLAY8

ACCESSORIES9

FUNCTIONS11

HOW TO USE THE MICROWAVE OVEN14

USING THE APPLIANCE FOR THE FIRST TIME14

DAILY USE15

USEFUL TIPS17

COOKING TABLES19

TESTED RECIPES21

CLEANING22

TROUBLESHOOTING23

PRODUCT FICHE24

AFTER-SALES SERVICE24

Installation guide25

SAFETY INSTRUCTIONS

IMPORTANT TO BE READ AND OBSERVED

Before using the appliance carefully read these safety instructions.

Keep them close at hand for future reference.

These instructions and the appliance itself provide important safety warnings, to be observed at all times.

The manufacturer declines any liability for failure to observe these safety instructions, for inappropriate use of the appliance or incorrect setting of controls.

SAFETY WARNINGS

WARNING: The appliance and its accessible parts become hot during use, children less than 8 years of age shall be kept away unless continuously supervised. Children from 8 years old and above and persons with reduced physical, sensory or mental capabilities or lack of experience and knowledge can use this appliance only if they are supervised or have been given instructions on safe use and understand the hazards involved. Children must not play with the appliance. Cleaning and user maintenance must not be carried out by children without supervision.

WARNING: Avoid touching heating elements or interior surface - risk of burns.

WARNING : If the door or door seals are damaged, the oven must not be operated until it has been repaired by a competent person.

WARNING : Liquids and other foods must not be heated in sealed containers since they are liable to explode.

The microwave oven is intended for heating food and beverages. Drying of food or clothing and heating of warming pads, slippers, sponges, damp cloth and similar may lead to risk of injury, ignition or fire.

When heating food in plastic or paper containers, keep an eye on the oven due to the possibility of ignition. Microwave heating of beverages can result in delayed eruptive boiling, therefore care must be taken when handling the container.

The contents of feeding bottles and baby food jars shall be stirred or shaken and the temperature checked before consumption, in order to avoid burns.

Eggs in their shell and shole hard-boiled eggs should not be heated in microwave ovens since they may explode even after microwave heating has ended. Keep clothes or other flammable materials away from the appliance, until all the components have cooled down completely.

Overheated oils and fats catch fire easily. Always be vigilant when cooking foods rich in fat, oil or when adding alcohol (e.g. rum, cognac, wine) - risk of fire. Do not use your microwave oven for deep-frying, because the oil temperature cannot be controlled.

If the appliance is suitable for probe usage, only use a temperature probe recommended for this oven (if present).

Use oven gloves to remove pans and accessories, taking care not to touch the heating elements. At the end of cooking, exercise caution when opening the door, by letting the hot air or steam exit gradually before accessing the appliance.

Only use utensils suitable for use in a microwave oven.

Do not obstruct hot air vents at the front of the oven.

If smoke is emitted switch off or unplug the appliance and keep the door closed in order to stifle any flames.

PERMITTED USE

This appliance is solely for domestic, not professional use. Do not use the appliance outdoors.

Do not store explosive or flammable substances such as aerosol cans and do not place or use gasoline or other flammable materials in or near the appliance: a fire may break out if the appliance is inadvertently switched on.

CAUTION: The appliance is not intended to be operated by means of an external timer or separate remote controlled system.

This appliance is intended to be used in household and similar applications such as :

- Staff kitchen areas in shops, offices and other working environments;
- Farm houses;
- By clients in hotels, motels and other residential environments;
- Bed and breakfast type environments.

No other use is permitted (e.g. heating rooms).

INSTALLATION

Installation and repairs must be carried out by a qualified technician, in compliance with the manufacturer's instructions and local safety regulations. Do not repair or replace any part of the appliance unless specifically stated in the user manual.

Children should not perform installation operations. Keep children away during installation. Keep the packaging materials (plastic bags, polystyrene parts, etc.) out of reach of children, during and after the installation.

The appliance must be handled and installed by two or more persons. Use protective gloves to unpack and install the appliance.

After unpacking the appliance, make sure that it has not been

damaged during transport. In the event of problems, contact the dealer or your nearest After-sales Service.

The appliance must be disconnected from the power supply before any installation operation.

During installation, make sure the appliance does not damage the power cable.

Only activate the appliance when the installation has been completed.

This appliance is intended to be used built-in. Do not use it freestanding.

Carry out all cabinet cutting works before fitting the appliance in the furniture and carefully remove all wood chips and sawdust.

After installation, the bottom of the appliance must no longer be accessible.

Do not obstruct the minimum gap between the worktop and the upper edge of the oven.

Only remove the oven from its polystyrene foam base at the time of installation.

After unpacking the appliance, make sure that the appliance door closes properly.

In the event of problems, contact the dealer or your nearest After-sales Service.

.....

ELECTRICAL WARNINGS

For installation to comply with current safety regulations, an omnipolar switch with minimum contact gap of 3mm is required and the appliance must be earthed.

If the fitted plug is not suitable for your socket outlet, contact a qualified technician.

The power cable must be long enough to connect the appliance, once fitted in its housing, to the main power supply. Do not pull the power supply cable.

If the power cable is damaged, replace with an identical one.

The power cable must only be replaced by a qualified technician in compliance with the manufacturer instruction and current safety regulations. Contact an authorized service center.

For appliances with fitted plug, if the plug is not suitable for you socket outlet, contact a qualified technician.

Do not use extension leads, multiple sockets or adapters.

Do not operate this appliance if it has a damaged mains cord or plug, if it is not working properly, or if it has been damaged or dropped. Keep the cord away from hot surfaces.

The electrical components must not be accessible to the user after installation.

Do not touch the appliance with any wet part of the body and do not operate it when barefoot.

The rating plate is on the front edge of the oven (visible when the door is open).

In case of replacement of power cable, use only following type(s): H05 RR-F 3 x 1.5 mm².

It must be possible to disconnect the appliance from the power supply by unplugging it if plug is accessible, or by an accessible multi-pole switch installed upstream of the socket in conformity with national electrical safety standards.

.....

CLEANING AND MAINTENANCE

Wear protective gloves for cleaning and maintenance.

The appliance must be disconnected from the power supply before any maintenance operation.

Never use steam cleaning equipment.

WARNING : It is hazardous for anyone other than a competent person to carry out any service or repair operation that involves the removal of a cover which give protection against exposure to microwave energy.

WARNING : Ensure that the appliance is switched off before replacing the lamp to avoid electric shock.

Failure to maintain the oven in a clean condition could lead to deterioration of the surface that could adversely affect the life of the appliance and possibly result in a hazardous situation.

The oven shall be cleaned regularly and any food deposits removed.

Ensure the appliance is cooled down before carrying out any cleaning or maintenance.

Do not use harsh abrasive cleaners or sharp metal scrapers to clean the door glass since they can scratch the surface, which may result in shattering of the glass.

SAFEGUARDING THE ENVIRONMENT

DISPOSAL OF PACKAGING MATERIALS

The packaging material is 100% recyclable and is marked with the recycle symbol. 

The various parts of the packaging must therefore be disposed of responsibly and in full compliance with local authority regulations governing waste disposal.

SCRAPPING OF HOUSEHOLD APPLIANCES

When scrapping the appliance, make it unusable by cutting off the power cable and removing the doors and shelves (if present) so that children cannot easily climb inside and become trapped.

This appliance is manufactured with recyclable  or reusable materials. Dispose of it in accordance with local waste disposal regulations.

For further information on the treatment, recovery and recycling of household electrical appliances, contact your competent local authority, the collection service for household waste or the store where you purchase the appliance.

This appliance is marked in compliance with European Directive 2012/19/EU, Waste Electrical and Electronic Equipment (WEEE).

By ensuring this product is disposed of correctly, you will help prevent potential negative consequences for the environment and human health, which could otherwise be caused by inappropriate waste handling of this product.

The symbol 

on the product or on the accompanying documentation indicates that it should not be treated as domestic waste but must be taken to an appropriate collection center for the recycling of electrical and electronic equipment.

ENERGY SAVING TIPS

Only preheat the oven if specified in the cooking table or your recipe. Use dark lacquered or enamelled baking moduls as they absorb heat far better.

Switch the oven off 10/15 minutes before the set cooking time. Food requiring prolonged cooking will continue to cook even once the oven is switched off.

DECLARATION OF CONFORMITY

This appliance has been designed, constructed and distributed in compliance with the requirements of European Directives:
LVD 2014/35/EU,
EMC 2014/30/EU and
RoHS 2011/65/EU.

This appliance, which is intended to come into contact with foodstuffs, complies with European Regulation n. 1935/2004/EC.
This appliance meets the Eco Design requirements of European Regulations

n. 65/2014, and n. 66/2014 in conformity to the European standard EN 60350-1.

PRODUCT DESCRIPTION

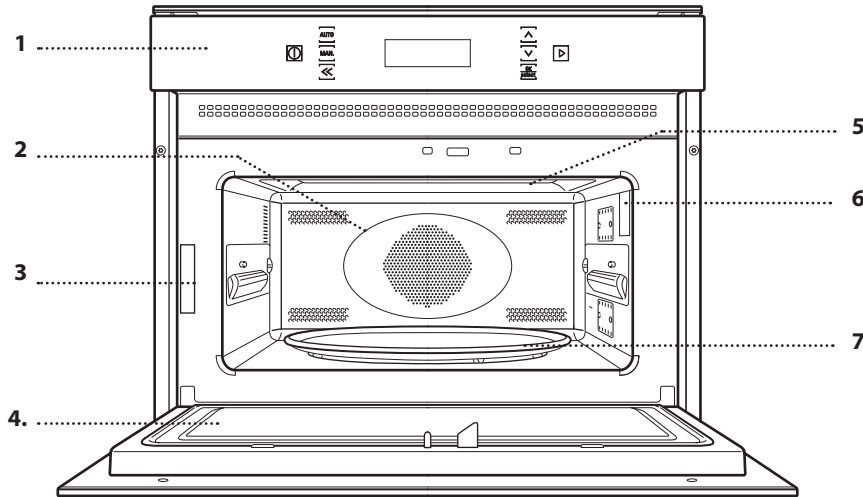

1. Control panel
2. Circular heating element (not visible)
3. Identification plate (do not remove)
4. Door
5. Upper heating element/grill
6. Light
7. Turntable

Note: Once cooking is complete and the oven has been switched off, the cooling fan may continue to run for a certain period of time.

CONTROL PANEL

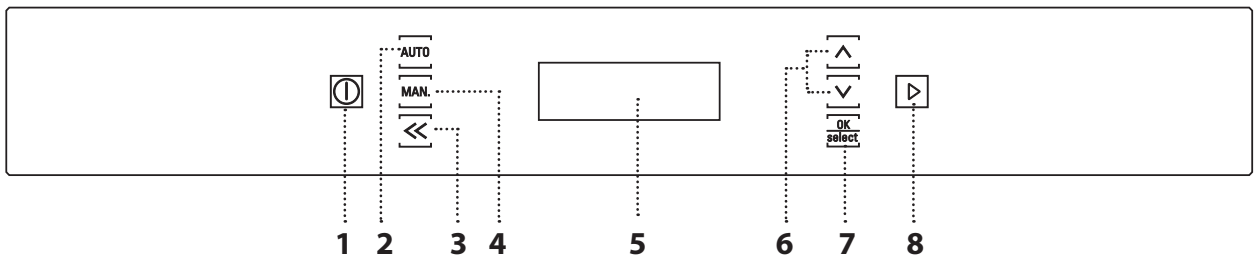

1. ON/OFF

For switching the oven on and off and for stopping an active function.

2. AUTOMATIC

For scrolling through the list of automatic functions.

3. BACK

For returning to the previous settings menu.

4. MANUAL

For scrolling through the list of manual functions.

5. DISPLAY

6. NAVIGATION BUTTONS

For changing the settings and values of a function.

7. CONFIRMATION BUTTON

For confirming a selected function or a set value.

8. START

For starting a function. When the oven is switched off, it activates the "Jet Start" microwave function.

DESCRIPTION OF DISPLAY

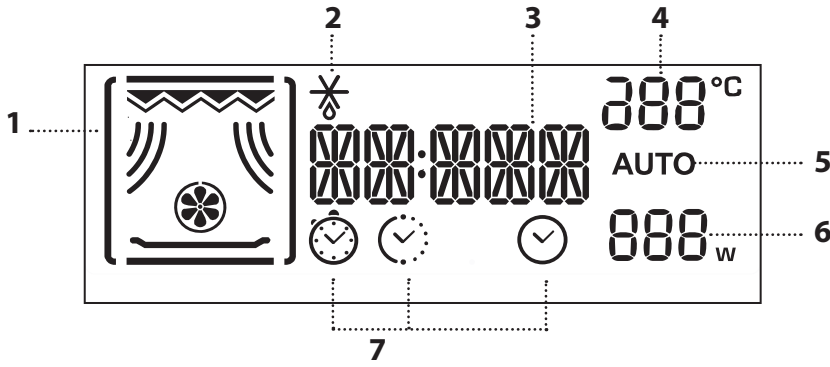

1. Symbol for the function selected
2. Defrost function
3. Clock; information and function duration
4. Function values (e.g. temperature, type of food, grill level)
5. Automatic
6. Microwave power
7. Timer setting, duration and clock.

ACCESSORIES

There are a number of accessories available on the market. Before you buy, ensure they are suitable for microwave use and resistant to oven temperatures.

Metallic containers for food or drink should never be used during microwave cooking. Always ensure that foods and accessories do not come into contact with the inside walls of the oven.

Always ensure that the turntable is able to turn freely before starting the oven. Take care not to unseat the turntable whilst inserting or removing other accessories.

TURNTABLE

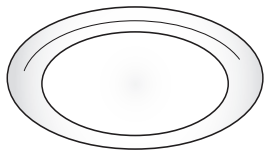

Placed on its support, the glass turntable can be used with all cooking methods. The turntable must always be used as a base plate for other containers and accessories.

TURNTABLE SUPPORT

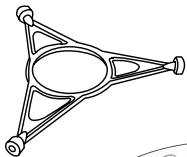

Only use the support for the glass turntable. Do not rest other accessories on the support.

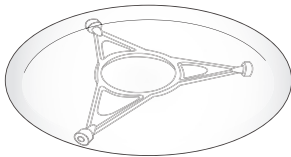

CRISP PLATE

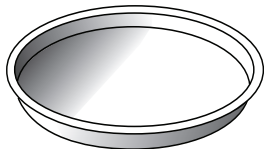

Only for use with the specific "Dynamic Crisp" function. The crisp plate must always be placed in the centre of the glass turntable and can be

preheated when empty, using the special function for this purpose only. Place the food directly on the crisp plate. Do not place any other accessories on the Crisp-plate, as the heat intensity reached could damage them.

HANDLE FOR THE CRISP PLATE

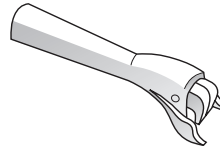

The Crisp-plate becomes extremely hot in just a short time: the supplied handle allows it to be removed from the oven.

Hook the handle to the edge of the Crisp-plate and squeeze firmly to ensure a good grip.

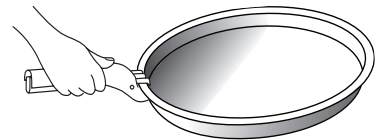

RECTANGULAR BAKING PLATE

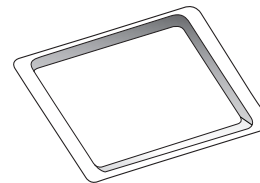

Only use the baking tray with functions that allow for forced air cooking; it must never be used in combination with microwaves.

Place the baking tray inside the oven horizontally, resting it on top of the appropriate guide inside the oven's chamber. When using the rectangular baking tray, the turntable can be left inside the oven.

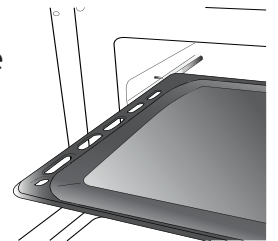

WIRE SHELF

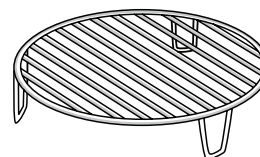

This allows you to place food closer to the grill, for perfectly browning your dish and for optimal hot air circulation.

Place the wire shelf on the turntable, making sure that it does not come into contact with other surfaces.

STEAMER

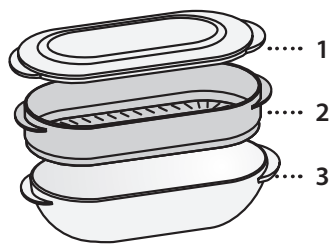

To steam foods such as fish or vegetables, place these in the basket (2) and pour drinking water (100 ml) into the bottom of the steamer (3) to achieve the right amount of steam.

To boil foods such as pasta, rice or potatoes, place these directly on the bottom of the steamer (the basket is not required) and add an appropriate amount of drinking water for the amount you are cooking. In order to make the most of the steam quality and guarantee the best possible cooking results, close the steamer with the appropriate cover (1).

Always place the steamer on the glass turntable and only use it with the appropriate cooking functions, or with microwave functions.

COVER

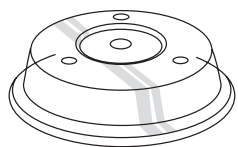

Useful for covering food while it is cooking or heating in the microwave.

The cover reduces splashes, keeps foods moist and can also be used to create two cooking

levels.

It is not suitable for use in forced air cooking or with any of the grill functions (including "Crisp Dynamic").



The number and type of accessories may vary depending on which model is purchased. Other accessories can be purchased separately from the After-sales Service.

FUNCTIONS

MAN.	MANUAL FUNCTIONS																
	<p>MICROWAVES For quickly cooking and reheating food or drinks.</p> <table border="1"> <thead> <tr> <th>POWER</th> <th>RECOMMENDED FOR</th> </tr> </thead> <tbody> <tr> <td>900 W</td> <td>Quickly reheating drinks or other foods with a high water content</td> </tr> <tr> <td>750 W</td> <td>Cooking vegetables</td> </tr> <tr> <td>650 W</td> <td>Cooking meat and fish</td> </tr> <tr> <td>500 W</td> <td>Cooking meaty sauces, or sauces containing cheese or egg. For finishing meat stews or baked pasta dishes</td> </tr> <tr> <td>350 W</td> <td>Slow, gently cooking. Perfect for melting butter or chocolate</td> </tr> <tr> <td>160 W</td> <td>Defrosting frozen foods or softening butter and cheese</td> </tr> <tr> <td>90 W</td> <td>Softening ice cream</td> </tr> </tbody> </table> <p>Recommended accessory: cover</p>	POWER	RECOMMENDED FOR	900 W	Quickly reheating drinks or other foods with a high water content	750 W	Cooking vegetables	650 W	Cooking meat and fish	500 W	Cooking meaty sauces, or sauces containing cheese or egg. For finishing meat stews or baked pasta dishes	350 W	Slow, gently cooking. Perfect for melting butter or chocolate	160 W	Defrosting frozen foods or softening butter and cheese	90 W	Softening ice cream
POWER	RECOMMENDED FOR																
900 W	Quickly reheating drinks or other foods with a high water content																
750 W	Cooking vegetables																
650 W	Cooking meat and fish																
500 W	Cooking meaty sauces, or sauces containing cheese or egg. For finishing meat stews or baked pasta dishes																
350 W	Slow, gently cooking. Perfect for melting butter or chocolate																
160 W	Defrosting frozen foods or softening butter and cheese																
90 W	Softening ice cream																
	<p>CRISP DYNAMIC Using the microwaves and the grill, the Crisp-plate quickly reaches the ideal temperature for perfectly browning both the upper and lower surfaces of the food. Use this function to reheat and cook pizzas, or other dough-based food. It is also good for frying bacon and eggs, sausages, potatoes, french fries, hamburgers and other meats, etc. without adding oil (or by adding only a very limited quantity of oil). This function must only be used with the special Crisp-plate provided, which must be placed at the centre of the glass turntable. It is recommended to preheat the plate for 2-3 minutes before cooking any food items that do not require long cooking times, like pizza or desserts.</p> <p>Required accessories: Crisp plate, handle for the crisp plate</p>																



GRILL

For browning, grilling and gratins. It is recommended to turn the food items during the cooking process.

It is useful for browning foods like cheese on toast, hot sandwiches, potato croquettes, sausages and vegetables. It is recommended to arrange the food items on the wire shelf and to turn them during the cooking process.

Ensure that the utensils utilized are heat resistant and suitable for oven cooking purposes. For best results, preheat the grill for 3-5 minutes.

Recommended accessories: **wire shelf**



GRILL + MICROWAVES

For quickly cooking entrées (even au gratin) using both microwaves and the grill. It is useful for cooking food like lasagne, fish and potato gratins.

Arrange the food items on the wire shelf, on the glass turntable, or in microwave-safe containers suitable for oven use.

Recommended accessories: **wire shelf**



TURBO GRILL + MICROWAVE

For quickly cooking and browning your food, combining the microwave, grill and forced air oven functions. It is designed for quickly cooking and roasting poultry or large cuts of meat (legs, roast beef, poultry), stuffed vegetables and roast potatoes. Place food on the wire rack or on the glass turntable. Place food on the wire shelf, on the glass turntable or in microwave-safe containers suitable for oven use. The oven does not have to be preheated.

Recommended accessories: **wire shelf**

FORCED AIR

For cooking dishes in a way that achieves similar results to using a conventional oven. It can be used for cooking meringues, biscuits, sponge cakes, soufflés, poultry and roasting joints. This function can be used to cook food at a maximum temperature of 250 °C for 30 minutes. Once this time has elapsed, the temperature automatically drops to 200°C.

It is recommended to place the food items on the wire shelf in order to ensure adequate air circulation.

The baking tray or other cookware that is suitable for oven use can be used to cook certain foods.

Recommended accessory: Rectangular baking tray/wire shelf

FORCED AIR + MICROWAVES

For preparing oven-baked dishes in a short amount of time. This function combines microwave and forced air functions, meaning that you can rapidly cook oven-baked dishes. It is useful for cooking roast meats, poultry, and jacket potatoes, frozen convenience foods, sponge cakes, pastry, fish and puddings. It is recommended to always place the food items on the wire shelf in order to ensure adequate air circulation.

Recommended accessories: wire shelf

QUICK REHEAT

For quickly reheating the oven before a cooking cycle.

Wait for the function to finish before placing food inside the oven.

TIME SETTINGS

For changing the oven settings (language, time, brightness, audible signal volume, Eco mode).

Please note: When Eco mode is active, the brightness of the display will be reduced after a few seconds to save energy. It is reactivated automatically whenever any of the buttons are pressed, etc.

AUTO

AUTOMATIC FUNCTIONS

With the automatic functions, simply select the type and weight or quantity of food to achieve the best results. The oven will automatically calculate the optimum settings and continue to change them as cooking progresses. The total time does not include preparation or preheating phases.





DEFROST DYNAMIC

For quickly defrosting various different types of food simply by specifying their weight.

Food should be placed directly onto the glass turntable. Turn the food when prompted.

Food should be placed directly onto the glass turntable. Turn the food when prompted.

A standing time always improves the result.

CATEGORY	RECOMMENDED FOODS	WEIGHT
 1*	MEAT (mince, cutlets, steaks, roasting joints)	100 g - 2 kg
 2*	POULTRY (whole chicken, pieces, fillets)	100 g - 2.5 kg
 3*	FISH (whole, steaks, fillets)	100 g - 1.5 kg
 4*	VEGETABLES (mixed vegetables, peas, broccoli, etc.)	100 g - 1.5 kg
 5*	BREAD (loaves, buns, rolls)	100 g - 2 kg

REHEAT DYNAMIC

For reheating ready-made food that is either frozen or at room temperature. The oven will automatically calculate the power level and the time necessary to obtain the best possible results in the least amount of time. A standing time always improves the result, especially for frozen food.

Arrange the food on a heat and microwave-resistant plate, and cover it if possible.

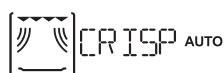
**CRISP DYNAMIC**





For quickly reheating and cooking frozen foods and giving them a golden, crunchy top. Only use this function with the crisp plate provided. Turn the food when prompted. If necessary, wait for the crisp plate to finish preheating before adding food.

CATEGORY	FOOD	WEIGHT
 1*	FRENCH FRIES (spread out in a single layer and sprinkle with salt before cooking)	300 - 600 g
 2*	PIZZA, THIN CRUST	250 - 500 g
 3*	PIZZA, THICK CRUST	300 - 800 g
 4*	CHICKEN WINGS, CHICKEN PIECES (Lightly oil the plate)	300 - 600 g
 5*	FISH FINGERS Crisp plate must be preheated	200 - 600 g

Required accessories: Crisp plate, handle for the crisp plate

**COOK DYNAMIC**

For oven-cooking foods quickly and achieving optimal results. Use cookware that is suitable for oven cooking and resistant to microwaves.

CATEGORY	FOOD	WEIGHT
 1	Roast chicken	800 g - 1.5 kg
 2	Biscuits	1 batch
 3	Whole fish	600 g - 1.2 kg
 4	Potato gratin	800 g - 2 kg
 5	Roast beef	800 g - 1.5 kg

**DYNAMIC STEAM**

This function allows for healthy and natural dishes to be obtained thanks to the properties of the steam itself, which is obtained using the special supplied steamer unit.

Use this function to steam cook foods such as fish or vegetables.

The preparation phase automatically generates steam, bringing the water poured into the bottom of the steamer to the boil. Timings for this phase may vary. The oven then proceeds with steam-cooking the food, according to the time set.

Some indicative cooking times are as follows:

- for FRESH VEGETABLES (250-500 g): 4-6 minutes;
- FROZEN VEGETABLES (250-500 g): 5-7 minutes;
- FISH FILLETS (250-500 g): 4-6 minutes.

Required accessory: **Steamer**

HOW TO USE THE MICROWAVE OVEN

USING THE APPLIANCE FOR THE FIRST TIME

Read the safety instructions carefully before using the product.

1. SELECT THE LANGUAGE

You will need to set the language and the time when you switch on the appliance for the first time: "ENGLISH" will scroll along the display.



Use **^** or **v** to scroll through the list of available languages and select the one you require. Press **OK select** to confirm your selection.

Please note: The language can subsequently be changed from the "Settings" menu.

2. SET THE TIME

After selecting the language, you will need to set the current time: The two digits for the hour will flash on the display.

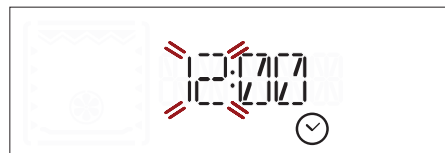

Use **^** or **v** to set the correct hour and press **OK select** to confirm: The minutes will flash on the display.

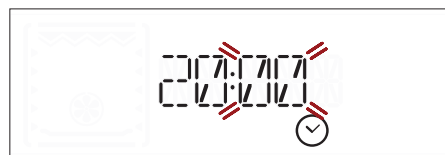

Use **^** or **v** to set the minutes and press **OK select** to confirm.

Please note: You may need to set the time again following lengthy power outages.

New ovens may emit odours due to the processing operations carried out at the factory.

Before starting to cook food, we therefore recommend heating the oven with it empty in order to remove any possible odours.

Remove any protective cardboard or transparent film from the oven and remove any accessories from inside it.

Heat the oven to 200 °C for about 1 hour using the "Forced Air" function.

Follow the instructions for setting the function correctly.

Aerate the room during and after the oven's first use.

DAILY USE

1. SELECT A FUNCTION

Press **ⓘ** to switch on the oven, then use **AUTO** or **MAN.** to access the menus for the manual and automatic functions.

To scroll through the menu, keep pressing **AUTO** or **MAN.** until the function you require is shown on the display: The display will show the icon for the function and the basic settings for it that you can change.

2. SET THE FUNCTION

After having selected the function you require, you can change its settings.

The display will show the settings that can be changed in sequence.



When the value starts flashing on the display, press **▲** or **▼** to change it, then press **OK select** to confirm and continue with the settings that follow.



Note: Pressing **◀** allows you to change the previous setting again.

3. ACTIVATE THE FUNCTION

Once you have applied the settings you require, press **▶** to activate the function.



You can press **ⓘ** at any time to pause the function that is currently active.

. SAFETY LOCK

This function is automatically activated to prevent the oven from being switched on accidentally.



Open and close the door, then press **▶** to start the function.

. PAUSE

To pause an active function, for example to stir or turn the food, simply open the door.

To start it up again, close the door and press **▶**

. JET START

When the oven is switched off, press **▶** to activate cooking with the microwave function set at full power (900 W) for 30 seconds.

Every time the **▶** button is pressed again, the cooking time will be increased by a further 30 seconds.

. AUTOMATIC FUNCTIONS AUTO

CATEGORIES

When using certain automatic functions, you will need to select a category for the food you are cooking in order to achieve the best results.

The reference category corresponds to the number indicated at the top right of the display.

Refer to the table containing descriptions of the functions for information on all of the categories.



Once you have selected the category, most of the automatic functions will also require you to enter the weight of the food.

DEGREE OF DONENESS

Most of the automatic functions will prompt you to select how well done (minimum, low, medium, high, maximum) you require the food to be. The degree of doneness can only be altered during the first 20 seconds of operation after activating the function: Activate the function and then press **▲** or **▼** to select the setting you require.



ACTIONS (STIRRING OR TURNING FOOD)

Certain automatic functions require you to turn or stir the food, for example, and will pause in order for you to do so.



Once the oven has paused cooking, open the door and carry out the action you are prompted to perform. Then close the door again and press **▶** to continue cooking.

Please note: When using the "Dynamic defrost" function, the function will start again automatically after two minutes, even if you have not turned or stirred the food.

. RESIDUAL HEAT

Once the food has been cooked, the oven will often activate an automatic cooling process, the status of which will be indicated on the display.



To view the clock during this process, press **◀◀**

Please note: Opening the door will temporarily interrupt the process.

. TIMER

When the oven is switched off, the display can be used as a timer. To activate the function and set the length of time you require, press **▲** or **▼**.



Press **OK/select** to activate the timer: An audible signal will sound and the display will indicate once the timer has finished counting down the selected time.

Please note: The timer does not activate any of the cooking cycles.

To change the time set for the timer, press **◀◀** to pause it and then press **◀◀** twice to go back to viewing the current time.

Once the timer has been activated, you can activate a function as well: The timer will continue to count down the selected time automatically without having any effect on the function.



To go back to viewing the timer, wait for the function to finish or switch off the oven by pressing **Ⓛ**

. SETTINGS

To change the oven settings, keep pressing **MAN.** until "SETTINGS" appears on the display and then press **OK/select** to access the menu.

Use **▲** or **▼** to scroll through the menu and press **OK/select** to access the setting you would like to change.

Use **▲** or **▼** to change the setting and press **OK/select** to confirm.

USEFUL TIPS

HOW TO READ THE COOKING TABLE

The table indicates the best functions to use for any given food.

The cooking times refer to the food cooking cycle inside the oven, excluding the pre-heating phase (where required).

The cooking values and times are indicative, and depend upon the amount of food and the types of accessories utilized.

Always cook food for the minimum cooking time given and check that it is cooked through.

In order to obtain optimal results, carefully follow the recommendations contained in the cooking table when selecting the accessories.

MICROWAVE COOKING TIPS

Since microwaves penetrate the food to a limited depth, if there are a number of pieces to cook at once, arrange the pieces in a circle to create more outside pieces.

Small pieces cook more quickly than large pieces: in order to ensure uniform cooking, cut the food items into pieces of equal size.

Moisture evaporates during the microwave cooking process: using a microwave-resistant cover helps reduce moisture loss.

Most foods will continue to cook after microwave has finished cooking it. Therefore, always allow for standing time to complete the cooking.

It is recommended to mix the food items during the microwave cooking process. When stirring, bring the cooked portions on the outside edges towards the centre and the less-cooked centre portions towards the outside.

Place thin slices of meat one on top of another or overlapping. Thicker slices, such as meat loaf and sausage, should be placed next to one another.

CLING FILM AND PACKAGING

Remove any wire twist-ties from paper or plastic bags before placing them in the oven for microwave cooking purposes.

Plastic film should be scored or perforated with a fork in order to relieve the pressure and prevent bursting due to the steam building up during the cooking process.

LIQUIDS

Liquids may overheat beyond boiling point without visibly bubbling.

This could cause hot liquids to suddenly boil over.

To prevent this possibility:

- Avoid using containers with narrow necks.
- Stir the liquid before placing the container in the microwave oven cavity and leave the teaspoon in the container.
- After heating, stir again before carefully removing the container from the microwave oven.

FROZEN FOOD

For best results, we recommend defrosting directly on the glass turntable. If needed, it is possible to use a light-plastic container that is suitable for microwave.

Boiled food, stews and meat sauces defrost better if stirred during the defrosting time.

Separate the food items once they begin to defrost: the separated portions will defrost more quickly.

FOOD FOR INFANTS

After heating baby food or liquids in a baby bottle or in a baby food jar, always stir and check the temperature before serving.

This will ensure that the heat is evenly distributed and avoid the risk of scalding or burns.

Ensure the lid and the teat is removed before heating.

CAKES AND BREAD

For cakes and bread products it is recommended to use the "Forced Air" function. Alternatively, in order to decrease the cooking times, the user can select "Forced Air + microwave", with the microwave power being set to a value no greater than 160W in order to maintain the food products soft and fragrant.

With the "Forced Air" function, use dark metal cake tins and always place them on the supply wire shelf.

Alternatively, the rectangular baking tray or other cookware suitable for oven use can be utilized to cook certain food items, such as biscuits or bread rolls.

If using the "Forced Air + microwave" function, only use containers suitable for microwaves, and place them on the supplied wire shelf.

To check whether the item you are baking is done, insert a skewer into the centre: If it comes out clean, the cake or bread is cooked.

If using non-stick cake tins, do not butter the edges as the cake may not rise evenly around the edges.

If the item "swells" during baking, use a lower temperature next time and consider reducing the

amount of liquid you add or stirring the mixture more gently.

If the base of the cake is soggy, lower the shelf and sprinkle the bottom of the cake with breadcrumbs or biscuit crumbs before adding the filling.

PIZZA

In order to obtain uniform cooking and a crispy pizza base in just a short time, it is recommended to use the "Dynamic Crisp" function together with the special supplied accessory.





















































Alternatively, for larger pizzas it is possible to use the rectangular baking tray together with the "Forced Air" function: in this case, pre-heat the oven to the temperature of 200° C and distribute the mozzarella on the pizza two-thirds of the way through the cooking process.









MEAT AND FISH























To obtain perfect surface browning quickly while keeping the inside of the meat or fish soft and juicy, we recommend using functions that combine air circulation with microwaves, such as "Turbo grill + microwave" or "Forced Air + microwave".

In order to obtain the best possible cooking results, set the microwave power level to the value of 350W.

COOKING TABLES









FOOD	FUNCTIONS	PREHEAT	TEMP. (°C)/GRILL LEVEL	POWER (W)	DURATION	ACCESSORIES
Sponge cakes		-	160-180	-	30-60	 
		-	160-180	90	25-50	 
Filled pies (cheesecake, strudel, apple tart)		Yes	160-190	-	35-70	 
Cookies		Yes	170-180	-	10-20	
Meringues		Yes	100-120	-	40-50	
Rolls		Yes	210-220	-	10-12	
Bread Loaf		Yes	180-200	-	30-35	
Pizza/Pie		Yes	190-220	-	20-40	
Pizza (0.4-0.5 kg)		-	-	-	14-16	
Quiche (vegetable tart, quiche lorraine)		Yes	180-190	-	40-55	 
Quiche Lorraine (1-1.2 kg)		-	-	-	18-20	
Lasagne/pasta bake			Medium	350-500	15-40	 
Roast lamb/veal/roast beef (1.3-1.5 kg)		-	170-180	-	70-80 *	 
		-	160-180	160	50-70 *	 
Roast beef – medium (1.3-1.5 kg)		-	170-180	-	40-60 *	 
Roast chicken/rabbit/duck (whole 1-1.2 kg)		-	210-220	-	50-70 *	 
		-	210-220	350	45-60 *	 
Chicken/rabbit/duck (fillets/pieces)		-	Medium - High	350-500	20-40 *	 
Chicken pieces (0.4-1 kg)		-	-	-	12-18	
Baked fish (whole)		-	High	160-350	20-40	 

FUNCTIONS	Crisp	Grill	Grill + Microwaves	Forced Air	Forced Air + Microwave
					
ACCESSORIES	Heatproof plate/container suitable for use in microwaves 	Wire shelf 	Crisp plate 	Rectangular baking plate 	

FOOD	FUNCTIONS	PREHEAT	TEMP. (°C)/GRILL LEVEL	POWER (W)	DURATION	ACCESSORIES
Fish fillets/slices		Yes	High	-	15-30 *	 
Stuffed vegetables (tomatoes, zucchinis, eggplants)		-	Medium	500-650	25-50	 
Toast		-	High	-	3-6	
Sausages/kebabs/spare ribs/hamburgers		-	Medium - High	-	20-40 *	
Sausages / Hamburgers (0.2-1 kg)		Yes**	-	-	6-16	
Baked potatoes		-	Medium	350-500	20-40 *	 
Potato wedges (0.3-0.8 kg)		-	-	-	10-20	
Baked fruit		-	Medium	160-350	15-25	 
Fried vegetables (0.3-0.8 kg)		Yes**	-	-	8-18	

















* Turn the food halfway through cooking

** Preheat the crisp plate for 3-5 minutes

FUNCTIONS	Crisp	Grill	Grill + Microwaves	Forced Air	Forced Air + Microwave
					
ACCESSORIES	Heatproof plate/container suitable for use in microwaves 	Wire shelf 	Crisp plate 	Rectangular baking plate 	

TESTED RECIPES

Compiled for the certification authorities in accordance with the standards IEC 60705 and IEC 60350

FOOD	FUNCTION	WEIGHT (G)	COOKING TIME (MIN:SEC)	GRILL TEMP. / LEV.	POWER (W)	PREHEAT	ACCESSORIES
Pastry cream		1000	12:00 - 13:00	-	650	-	Microwave-safe container (Pyrex 3.227)
Sponge cake		475	8:30-10:00	-	750	-	Microwave-safe container (Pyrex 3.827)
Meat loaf		900	13:00 - 14:00	-	750	-	Microwave-safe container (Pyrex 3.838)
Potatoes Gratin		1100	28:00 - 30:00	190	350	-	Microwave-safe container (Pyrex 3.827)
Desserts		700	28:00 - 30:00	175	90	-	Microwave-safe container (Pyrex 3.828)
Chicken		1200	35:00 - 40:00	210	350	-	Microwave-safe container (Pyrex 3.220)
Defrosting meat (turn halfway through the defrosting process)		500	10:00	-	160	-	Turntable
Toasted sandwiches		-	4:00 - 6:00	High	-	-	Wire shelf 
Small cakes		-	30:00 - 35:00	160	-	No	Rectangular baking plate 
Pastries and tartlets		-	18:00 - 20:00	170	-	Yes	Rectangular baking plate 
Fatless sponge cake		-	33:00 - 35:00	180	-	No	Wire shelf 
Apple pie		-	65:00 - 70:00	180	-	Yes	Wire shelf 

FUNCTIONS	Microwave	Grill	Forced Air	Forced Air + Microwave
				

CLEANING

Make sure that the oven has cooled down before carrying out any maintenance or cleaning.

Do not use steam cleaners.

Do not use wire wool, abrasive scourers or abrasive/corrosive cleaning agents, as these could damage the surfaces of the appliance.

INTERIOR AND EXTERIOR SURFACES

- Clean the surfaces with a damp cloth. If they are very dirty, add a few drops of pH-neutral detergent. Finish off with a dry cloth.
- Clean the door glass with a suitable liquid detergent.
- At regular intervals or in case of spills, remove the turntable and its support to clean the bottom of the oven, removing all food residue.
- The grill does not need to be cleaned as the intense heat burns away any dirt: Use this function

on a regular basis.

In order to remove particularly stubborn food residues, it is recommended to boil a cup of tap water by placing it in the microwave at maximum power for a few minutes: the resulting steam will soften the residues and facilitate their removal.

Please note: Adding lemon juice to the water helps to eliminate cooking odours.

ACCESSORIES

All accessories are dishwasher safe with the exception of the crisp plate.

The Crisp-plate must should be cleaned using tap water and a neutral detergent. For stubborn dirt, rub gently with a cloth. Always leave the crisp plate to cool down before cleaning.

Any problems or malfunctions that may occur can often be easily resolved. Before contacting the After-sales Service, check the following table to see whether you can resolve the problem yourself. If the problem persists, contact your nearest After-sales Service Centre.



Read the safety instructions carefully before carrying out any of the following work

Problem	Possible cause	Solution
The oven does not work	Power cut. Disconnection from the mains. Fault.	Check for the presence of mains electrical power and whether the oven is connected to the electricity supply. Turn off the oven and restart it to see if the fault persists.
The display does not turn on	Oven OFF	Press ⓘ to switch the oven ON.
The buttons do not respond	Oven OFF. Control panel dirty.	Press ⓘ to switch on the oven and see whether the problem persists. Clean the surface of the control panel with a microfibre cloth (see the "Cleaning" section).
The time of day is flashing	Power cut.	You need to reset the time: Follow the instructions given in the "Using the appliance for the first time" section.
The display shows the letter "F" followed by a number	Software fault.	Contact you nearest Client After-sales Service Centre and state the number following the letter "F".
The display's brightness is reduced	The ECO function is enabled.	From the "Settings" - "ECO" section, select the "No" option to deactivate it.
The oven makes noise, even when off	Cooling fan activated.	Open the door or wait until the cooling process has finished.

PRODUCT FICHE

 www.docs.hotpoint.eu A complete product specification, including the energy efficiency ratings for this oven, can be consulted at and downloaded from our website **docs.hotpoint.eu**

AFTER-SALES SERVICE

BEFORE CONTACTING OUR AFTER-SALES SERVICE

1. Check whether you can resolve the problem yourself using any of the measures described in the "Troubleshooting" section.

.....

2. Turn off the oven and restart it to see if the fault persists.

IF THE FAULT PERSISTS AFTER HAVING PERFORMED ALL OF THE NECESSARY CHECKS, CONTACT YOUR NEAREST AFTER-SALES SERVICE CENTRE.

To receive assistance, call the number given on the warranty leaflet enclosed with the product or follow the instructions on our website. Be prepared to provide:

- A brief description of the fault
- The exact type of model of your product
- The assistance code (the number following the word SERVICE on the identification plate attached to the product; this can be seen on the left-hand edge of the cooking compartment when the oven door is open).
- Your full address
- A contact telephone number

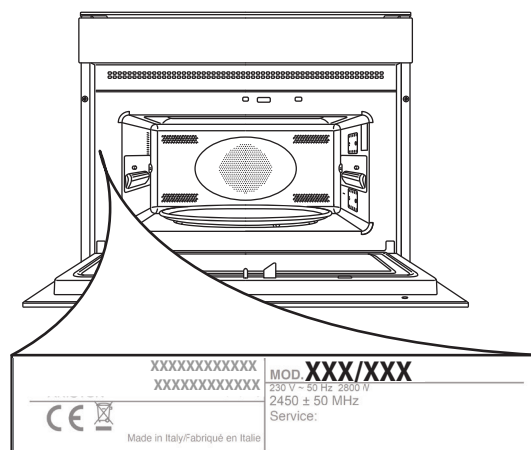

Please note: If repairs are required, contact an authorised service centre that is guaranteed to use original spare parts and perform repairs correctly.

Please refer to the enclosed warranty leaflet for more information on the warranty.

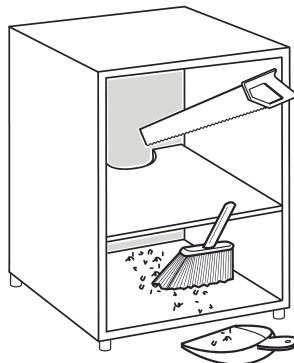
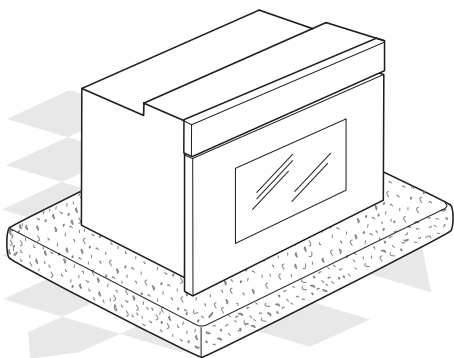
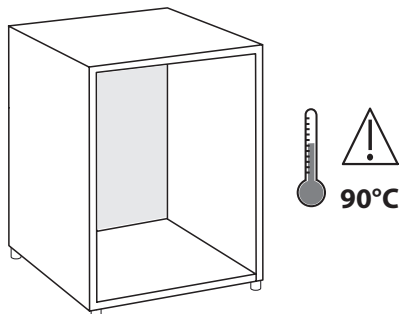
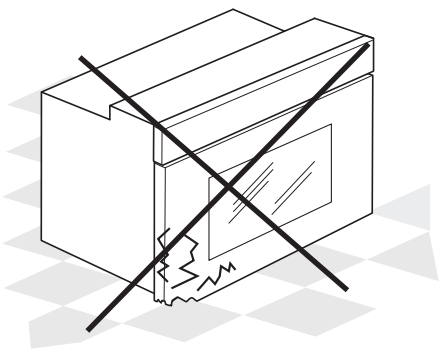
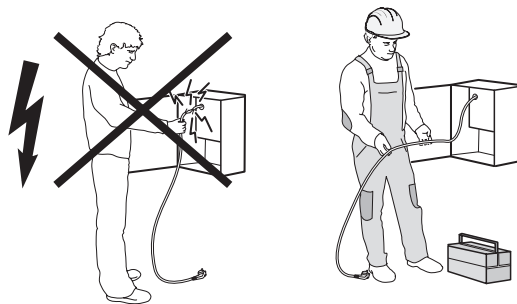
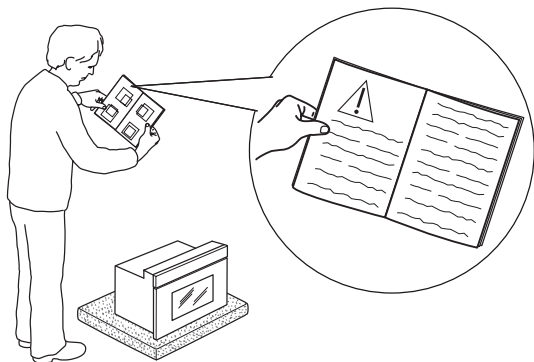
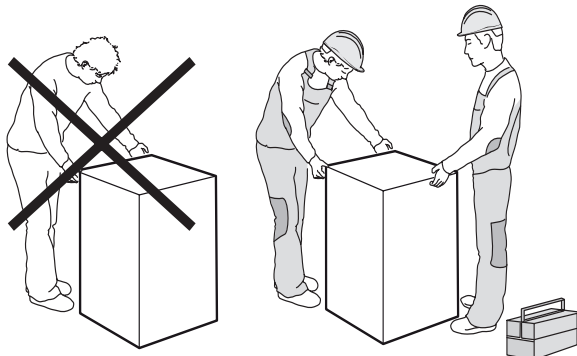
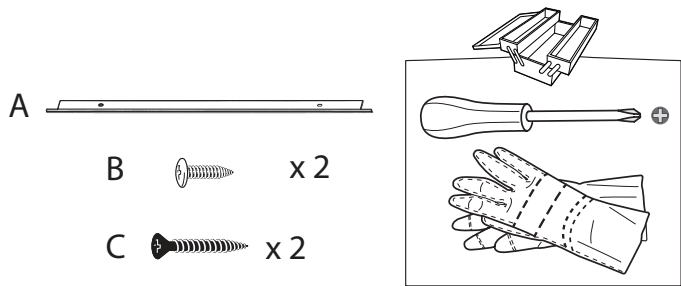

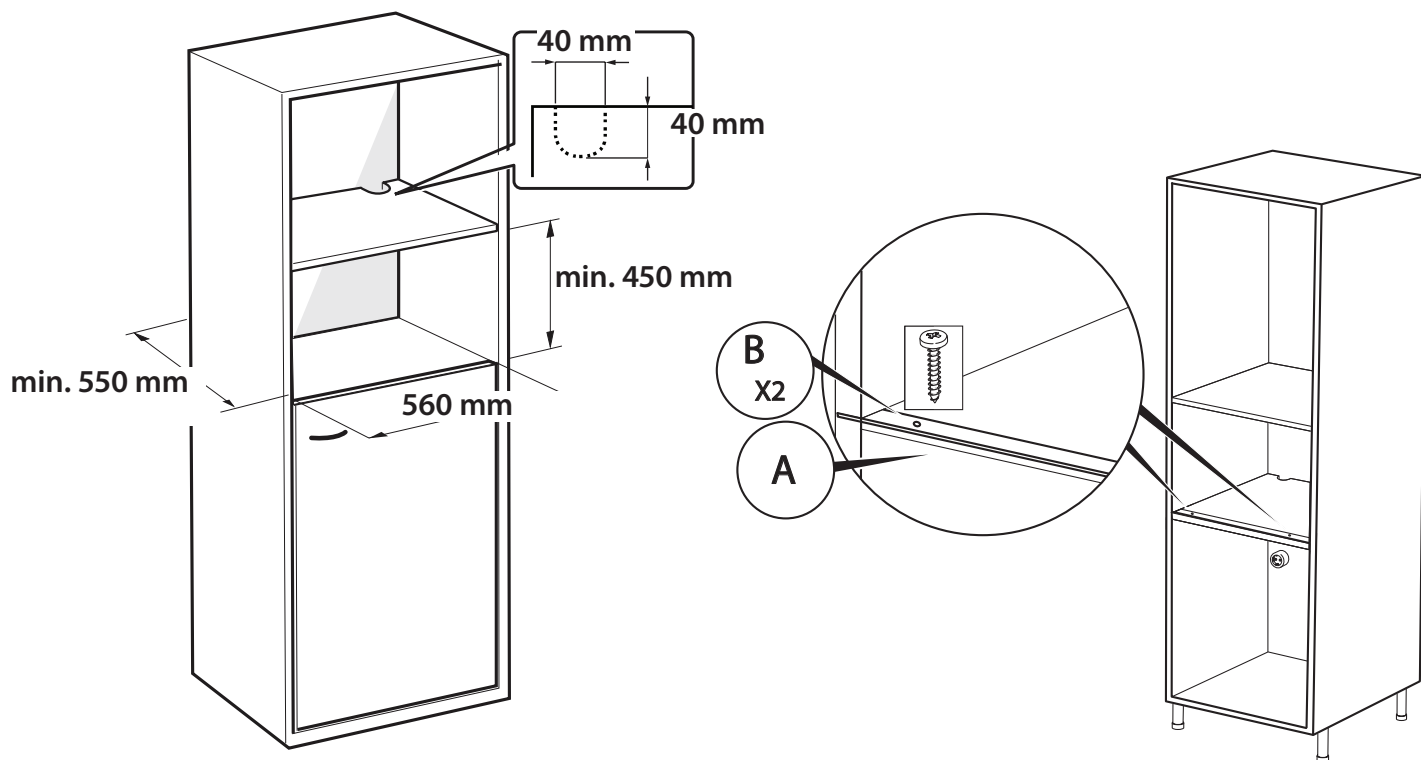
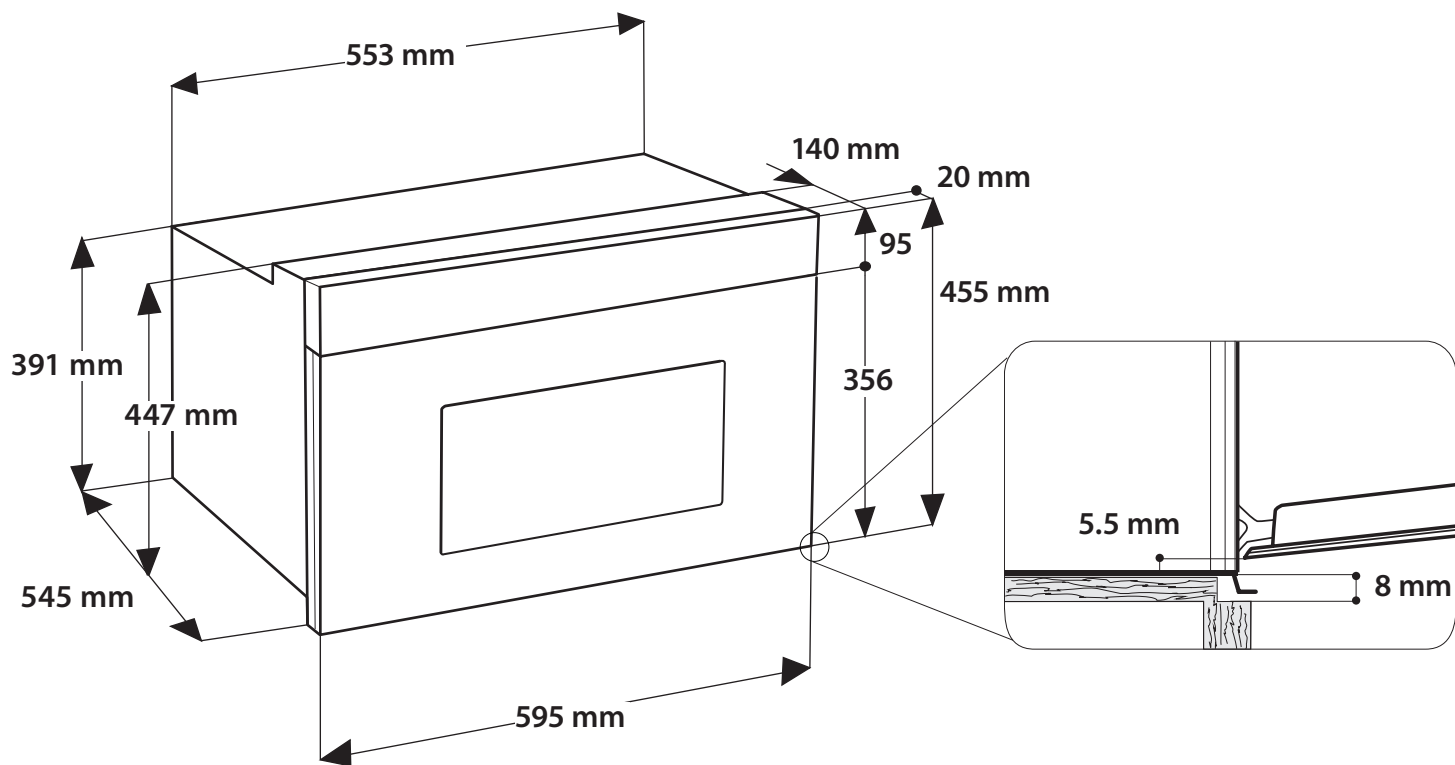

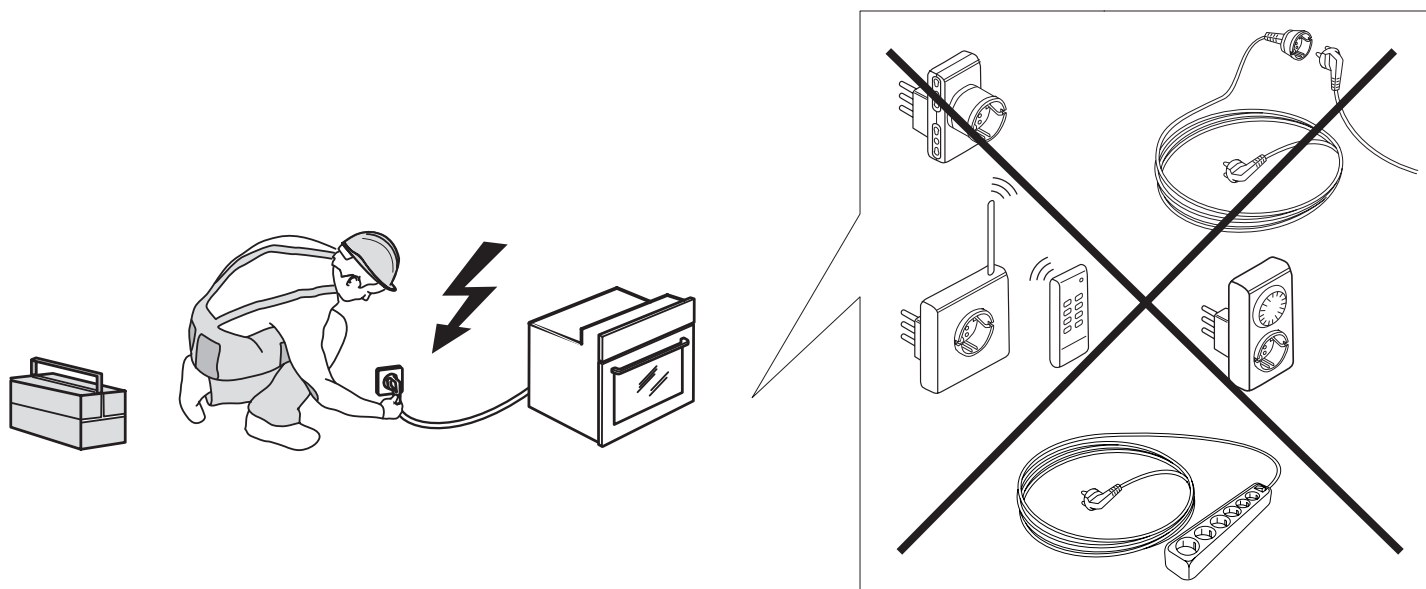
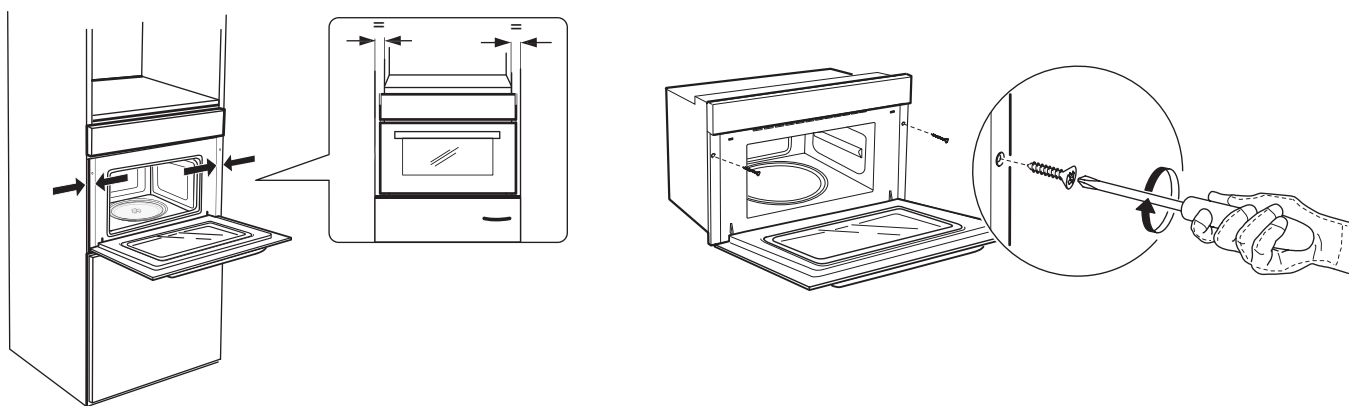
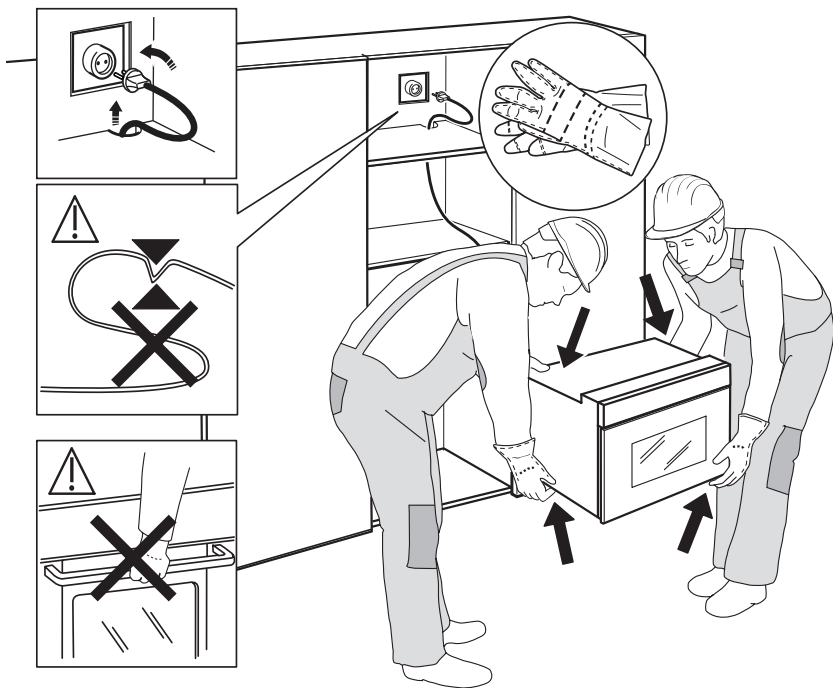

400010850931

Printed in Italy