

electriQ

USER MANUAL



FIVE-ZONE BUILT IN CERAMIC HOB

eiQC77V3

Thank you for choosing your electriQ ceramic hob.

This instruction manual is designed to provide you with all required instructions related to the installation, use and maintenance of the appliance. In order to operate the unit correctly and safely, please read this instruction manual carefully before installation and usage.

CONTENTS

SAFETY WARNINGS	3
INSTALLATION	6
PRODUCT OVERVIEW	9
OPERATION	10
TO START COOKING	11
BOOST FUNCTION	12
KEEP WARM FUNCTION	12
PAUSE FUNCTION	13
CHILD LOCK	14
TIMER	15
CARE AND CLEANING	17
HINTS AND TIPS	21
TECHNICAL SPECIFICATION	21
SUPPORT	22
PRODUCT FICHE	23

SAFETY WARNINGS

Your safety is important to us. Please read this information before using your hob.

ELECTRICAL SHOCK HAZARD

- Do not cook on a broken or cracked hob. If the surface should break or crack, switch the appliance off immediately at the mains power supply (wall switch) and contact a qualified technician.
- Switch the hob off at the wall before cleaning or maintenance.
- Failure to follow this advice may result in electrical shock or death.

HEALTH HAZARD

- This appliance complies with electromagnetic safety standards.

HOT SURFACE HAZARD

- During use, accessible parts of this appliance will become hot enough to cause burns.
- Do not let your body, clothing or any item other than suitable cookware contact the Ceramic glass until the surface is cool.
- Metallic objects such as knives, forks, spoons and lids should not be placed on the hob surface since they can get hot.
- Keep children away.
- Handles of saucepans may be hot to touch. Check saucepan handles do not overhang other cooking zones that are on. Keep handles out of reach of children.
- Failure to follow this advice could result in burns and scalds.

CUT HAZARD

- The razor-sharp blade of a cooktop scraper is exposed when the safety cover is retracted. Use with extreme care and always store safely and out of reach of children.
- Failure to use caution could result in injury or cuts.

IMPORTANT SAFETY INSTRUCTIONS

- Never leave the appliance unattended when in use. Boil over causes smoking and greasy spill overs that may ignite.
- Never use your appliance as a work or storage surface.
- Never leave any objects or utensils on the appliance.
- Never use your appliance for warming or heating the room.
- After use, always turn off the cooking zones and the hob as described in this manual (i.e. by using the touch controls).
- Do not allow children to play with the appliance or sit, stand, or climb on it.
- Do not store items of interest to children in cabinets above the appliance. Children climbing on the hob could be seriously injured.
- Do not leave children alone or unattended in the area where the appliance is in use.
- This appliance can be used by children aged from 8 years and above and persons with reduced physical, sensory or mental capabilities or lack of experience and knowledge if they have been given supervision or instruction concerning use of the appliance in a safe way and understand the hazards involved.
- Children less than 8 years of age shall be kept away unless continuously supervised.
- Do not repair or replace any part of the appliance unless specifically recommended in the manual. All other servicing should be done by a qualified technician.
- Do not use a steam cleaner to clean your hob.
- Do not place or drop heavy objects on your hob.
- Do not stand on your hob.
- Do not use pans with jagged edges, do not drag pans across the glass surface as this can scratch the glass.
- Do not use scourers or any other harsh abrasive cleaning agents to clean your cooktop, as these can scratch the glass.
- If the supply cord is damaged, it must be replaced by the

manufacturer, its service agent or similarly qualified persons in order to avoid a hazard.

- This appliance is intended to be used in domestic and similar applications and is not designed for commercial use.
- **WARNING:** The appliance and its accessible parts become hot during use.
- Care should be taken to avoid touching heating elements.
- Children shall not play with the appliance. Cleaning and user maintenance shall not be made by children without supervision.
- **WARNING:** Unattended cooking on a hob with fat or oil can be dangerous and may result in fire. NEVER try to extinguish a fire with water, but switch off the appliance and then cover flame e.g. with a lid or a fire blanket.
- **WARNING:** Danger of fire: do not store items on the cooking surfaces.
- **Warning:** If the surface is cracked, switch off the appliance to avoid the possibility of electric shock, for hob surfaces of glass-ceramic or similar material which protect live parts
- The appliance is not intended to be operated by means of an external timer or separate remote-control system.

INSTALLATION

CAUTION

1. The ceramic hob must be installed by qualified personnel or technicians. Please never conduct the operation by yourself.
2. The ceramic hob must not be mounted above or in close proximity to cooling equipment, dishwashers and rotary dryers.
3. The ceramic hob must be installed in a way that ensures good ventilation to the unit to enhance its reliability.
4. Ensure the wall, work surface and area around the hob are suitably heat resistant.
5. To avoid any damage, the sandwich layer and adhesive must be resistant to heat.

Cut a hole in the work surface according to the dimensions shown below.

For the purpose of installation and use, a minimum of 5 cm space must be preserved around the hole. Be sure the thickness of the work surface is at least 30mm. Please select a heat-resistant work surface material to avoid larger deformation caused by heat radiation from the hob, as shown below:

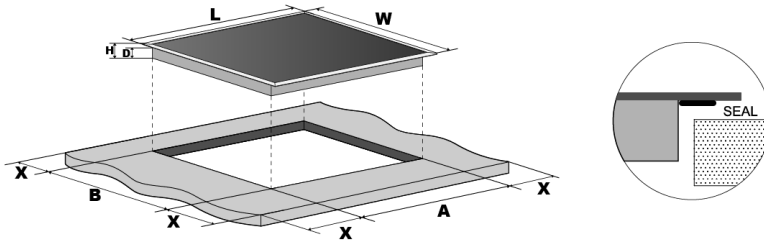

	L(mm)	W(mm)	H(mm)	D(mm)	A(mm)	B(mm)	X(mm)
eiQC77-V3	770	520	50	46	740	490	50 min

Ensure the ceramic hob is kept in a good condition, is well ventilated and the air inlet and outlet are not blocked, as shown on the following page:



Note: A safe distance of at least 760mm between the hob and the cupboard above must be maintained.

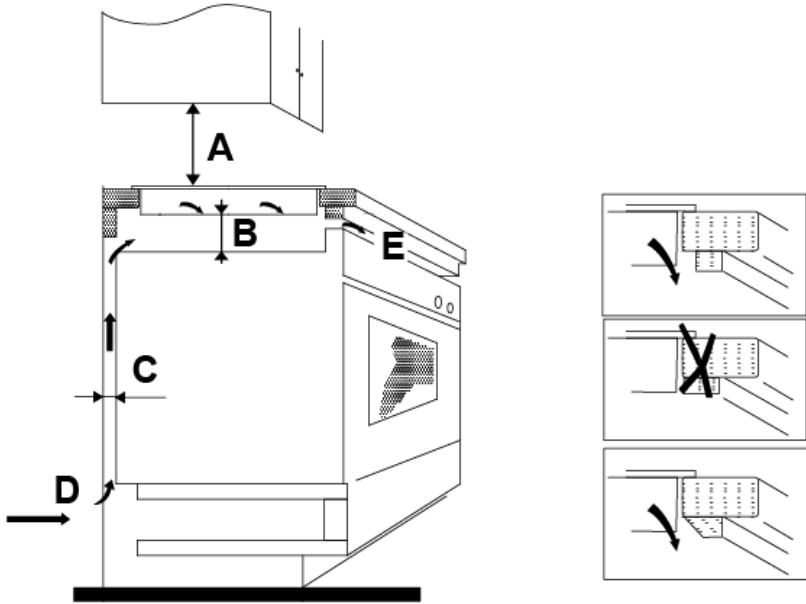

A(mm)	B(mm)	C(mm)	D	E
760	50 min	20 min	Air intake	Air exit 5mm

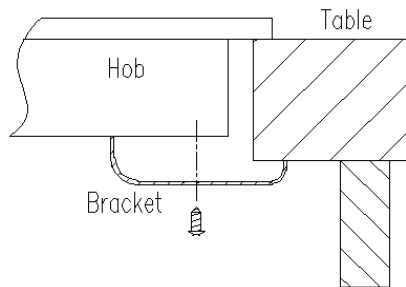
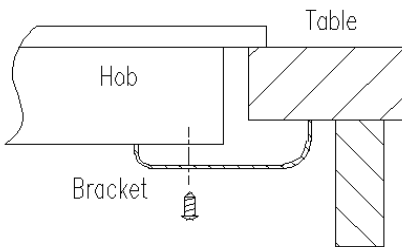

LOCATING THE FIXING BRACKETS

The unit should be placed on a stable, smooth surface (use the packaging). Do not apply force onto the controls protruding from the hob.

Fix the hob to the work surface by screwing the four brackets to the underside of the hob as shown above.

CONNECTING THE HOB TO THE MAINS POWER SUPPLY

The power supply should be connected in compliance with the relevant local regulations. The method of connection is shown below.

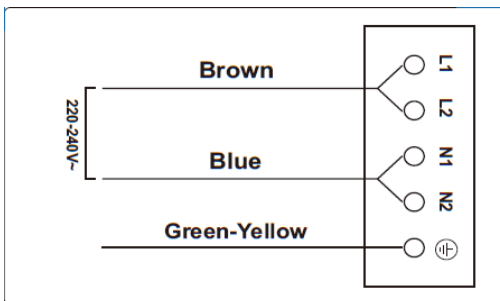

If the cable is damaged or needs replacing, this should be done by an after-sales technician using appropriate tools.

If the appliance is being connected directly to the mains supply, a dual pole circuit breaker must be installed with a minimum gap of 3mm between the contacts.

The installer must ensure that the correct electrical connection has been made and that it complies with safety regulations.

The cable must not be bent or compressed.

The cable must be checked regularly and only replaced by a properly qualified person.

PRODUCT OVERVIEW

Your hob has five heating zones with a choice of different heating capabilities.

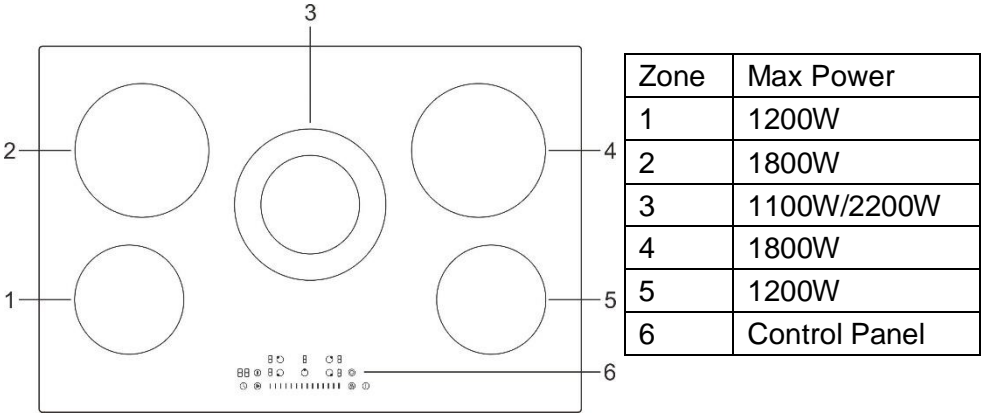

CONTROL PANEL

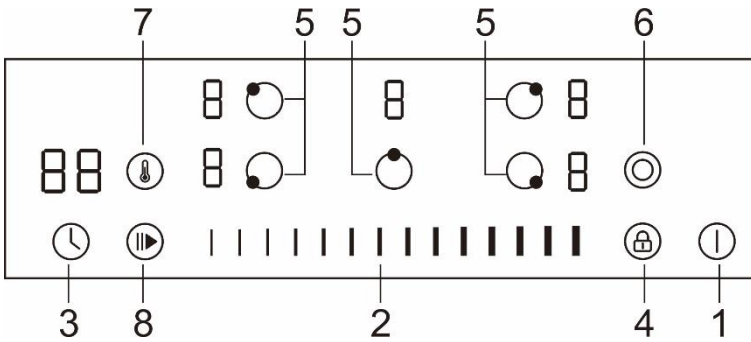

- 1. ON/OFF switch
- 2. Power level selection
- 3. Timer select
- 4. Child lock
- 5. Heating zone select
- 6. Boost function
- 7. 'Keep warm' function
- 8. Pause

OPERATION

BEFORE USING YOUR NEW CERAMIC HOB

- Read this guide, taking special note of the 'Safety Warnings' section.
- Remove any protective film that may still be on your ceramic hob.

USING THE TOUCH CONTROLS

- The controls respond to touch, so you don't need to apply any pressure.
- Use the ball of your finger, not its tip.
- You will hear a beep each time a touch is registered.
- Make sure the controls are always clean, dry, and that there is no object (e.g. a utensil or a cloth) covering them. Even a thin film of water may make the controls difficult to operate.

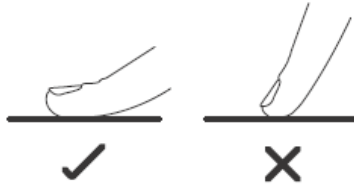

Choosing the right cookware

Do not use cookware with jagged edges or a curved base.



Make sure that the base of your pan is smooth, sits flat against the glass, and is the same size as the cooking zone. Always centre your pan on the cooking zone.

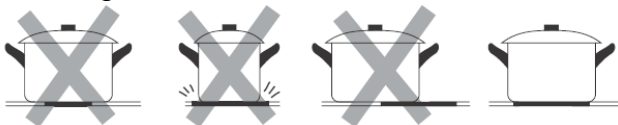

Always lift pans off the ceramic hob – do not slide, or they may scratch the glass.

TO START COOKING

After the power is switched on, the buzzer will beep once, all the indicators will light for 1 second then go out, indicating that the ceramic hob has entered standby mode.

1. Touch the ON/OFF  button.

All the displays will show “-” or “- -”.



2. Place a suitable pan on the cooking zone that you wish to use. Make sure the bottom of the pan and the surface of the cooking zone are clean and dry.

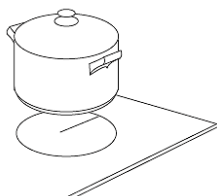

3. Touch the heating zone select button. An indicator next to the button will flash.



4. Select a heat setting by touching the slider control. If you don't choose a heat setting within 1 minute, the ceramic hob will automatically switch off. You will need to start again at step 1.

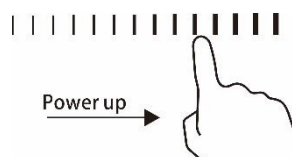

You can modify the heat setting at any time during cooking.

BOOST FUNCTION

Zone 3 has a special feature. It can be used as an 1100W zone and by pressing the Boost button , its power is doubled to 2200W. To turn the feature off, press the Boost button again.

KEEP WARM FUNCTION

The Keep Warm function instantly sets the selected heating zone to level 1.



Activate the Keep Warm function

1. Select the zone required to use the Keep Warm function.
2. Touch the keep warm button. The zone indication shows “|”

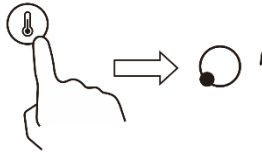

Cancel the Keep Warm function

1. Touch the heating zone select button.
2. a: Touching slider will cancel the keep warm function. The cooking zone will revert to the level you select.



- b: Touch another function button. The cooking zone will revert to your selection.

PAUSE FUNCTION

1. Select the pause control  All the heating zones stop working, All the zone displays show “||”

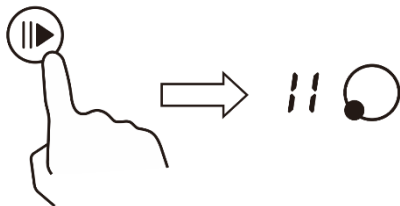

2. Touch the pause control  one more time, and all the heating zones revert to their original settings.

- This function is available when one or more heating zones are working.
- If you don't cancel the pause control within 30 minutes, the induction hob will automatically switch off.
-

WHEN YOU HAVE FINISHED COOKING

1. On the controls for the zone you want to turn off, press the slider button repeatedly until the power level shows “0”



2. Turn the whole hob off by touching the “ON/OFF” button.

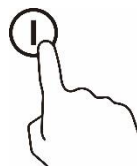

BEWARE OF HOT SURFACES

When a cooking zone is turned off “H” will be displayed to show that the cooking zone is still hot to touch. It will disappear when the surface has cooled down to a safe temperature.



It can also be used as an energy saving function if you want to heat further pans, use the hotplate that is still hot.

CHILD LOCK

- You can lock the controls to prevent unintended use (for example children accidentally turning the cooking zones on).
- When the buttons are locked, all buttons except the ON/OFF button are disabled.

TO LOCK THE CONTROLS

Touch the lock  button. The timer indicator will show “Lo”.

TO UNLOCK THE CONTROLS

1. Make sure the ceramic hob is turned on.
2. Hold the lock button  for 3 seconds to release the lock.
3. You can now start using your ceramic hob.



When the hob is in lock mode, all the controls are disabled apart from the ON/OFF  button. The ON/OFF button can still be used in an emergency to turn the hob off, but the hob must be unlocked before turning the hob back on.

OVER-TEMPERATURE PROTECTION

A temperature sensor monitors the temperature inside the ceramic hob. When an excessive temperature is detected, the ceramic hob will stop operation automatically.

AUTO SHUTDOWN

Another safety feature of the hob is auto shut down. Should you forget to switch off a cooking zone, it is automatically shut down according to the table below.

Power level	1	2	3	4	5	6	7	8	9
Default working timer (hour)	8	8	8	4	4	4	2	2	2

USING THE TIMER

You can use the timer in two different ways:

- You can use it as a minute minder. In this case, the timer will not turn any cooking zone off when the set time elapses.
- You can set it to turn one or more cooking zones off after the set time elapses.

You can set the timer for up to 99 minutes.

USING THE TIMER AS A MINUTE MINDER IF YOU ARE NOT SELECTING ANY COOKING ZONE

1. Make sure the hob is turned on and zone select key is not activated (zone indication '-' is not blinking).

Note: you can set minute minder before or after cooking zone power setting finished.

2. Touch timer key, "00" will show in the timer display and "0" will flash.



3. Set the time by touching the slider control of the timer (e.g. 5)

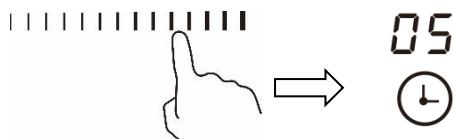

4. Touch timer control again, then "0" will flash.



5. Set the time by touching the slider. You have now set the time at 95 minutes for example.

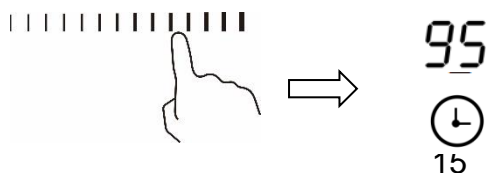

6. Once the time is set, it begins to count down immediately. The display will show the remaining time.



7. When the time is up, a buzzer will beep for 30 seconds and the timer indicator will show "- -".

USING THE TIMER WITH MULTIPLE COOKING ZONES

1. Select the heating zone that you want to set the timer for.



2. Touch the timer control. The "00" will show in the timer display. And the "0" flashes.

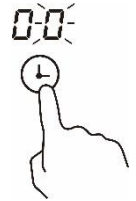

3. Set the time by touching the slider control

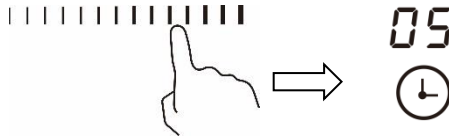

4. Touch the timer control again, the "0" will flash.



5. Set the time with slider control. Now for example the timer is set at 95 minutes.

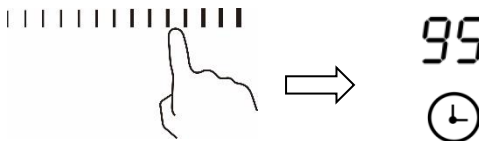

6. Once the time is set, it will begin to count down



immediately.

The display will show the remaining time.

NOTE: There will be a red dot in the right bottom corner of power level indication which indicating that zone is selected.

7. When the timer is complete, the corresponding cooking zone will be switched off automatically.

Note: Other cooking zones will keep operating if they are turned on previously.

IF THE TIMER IS SET ON MORE THAN ONE ZONE:

When you set timer for several cooking zones, red dots of the relevant cooking zones are indicated. The timer display shows the minimum timer. The dot of the corresponding zone blinks.



2. Once the countdown timer expires, the corresponding zone will switch off. Then it will show the new minimum timer and the dot of corresponding zone will flash.

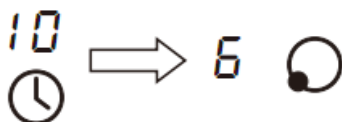

Note: Touch the heating zone selection control, the corresponding timer will be shown in the timer indicator.

CANCELLING THE TIMER

1. Touch the heating zone selection control that you want to cancel.

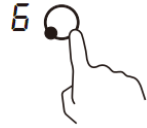

2. Touch the timer control. The indicator will flash.



3. Touch the slider control to set the timer to “00”. The timer is now cancelled.

HEAT SETTINGS

Heat setting	Suitability
1 – 2	<ul style="list-style-type: none">• delicate warming for small amounts of food• melting chocolate, butter and foods that burn quickly• gentle simmering• slow warming
3 – 4	<ul style="list-style-type: none">• reheating• rapid simmering• cooking rice
5 – 6	<ul style="list-style-type: none">• pancakes
7 – 8	<ul style="list-style-type: none">• sautéing• cooking pasta
9	<ul style="list-style-type: none">• stir-frying• searing• bringing soup to the boil• boiling water

COOKING GUIDELINES

COOKING TIPS

- When food comes to the boil, reduce the power setting.
- Using a lid will reduce cooking times and save energy by retaining the heat.
- Minimise the amount of liquid or fat to reduce cooking times.
- Start cooking on a high setting and reduce the setting when the food has heated through.

Simmering, cooking rice

- Simmering occurs below boiling point, at around 85°C, when bubbles are just rising occasionally to the surface of the cooking liquid. It is the key to delicious soups and tender stews because the flavours develop without overcooking the food. You should also cook egg-based and flour thickened sauces below boiling point.
- Some tasks, including cooking rice by the absorption method, may require a setting higher than the lowest setting to ensure the food is cooked properly in the time recommended.

Searing steak

To cook juicy flavoursome steaks:

1. Stand the meat at room temperature for about 20 minutes before cooking.
2. Heat up a heavy-based frying pan.
3. Brush both sides of the steak with oil. Drizzle a small amount of oil into the hot pan and then lower the meat onto the hot pan.
4. Turn the steak only once during cooking. The exact cooking time will depend on the thickness of the steak and how cooked you want it. Times may vary from about 2 – 8 minutes per side. Press the steak to gauge how cooked it is – the firmer it feels the more 'well done' it will be.
5. Leave the steak to rest on a warm plate for a few minutes to allow it to relax and become tender before serving.

For stir-frying

1. Choose a ceramic compatible flat-based wok or a large frying pan.
2. Have all the ingredients and equipment ready. Stir-frying should be quick. If cooking large quantities, cook the food in several smaller batches.
3. Preheat the pan briefly and add two tablespoons of oil.
4. Cook any meat first, put it aside and keep warm.
6. Stir-fry the vegetables. When they are hot but still crisp, turn the cooking zone to a lower setting, return the meat to the pan and add your sauce.
7. Stir the ingredients gently to make sure they are heated through.
8. Serve immediately.

CARE AND CLEANING

What?	How?	Important!
<p>Everyday soiling on glass (fingerprints, marks, stains left by food or non-sugary spill overs on the glass)</p>	<ol style="list-style-type: none"> 1. Switch the power to the hob off. 2. Apply a hob cleaner while the glass is still warm (but not hot!) 3. Rinse and wipe dry with a clean cloth or paper towel. 3. Switch the power to the hob back on. 	<ul style="list-style-type: none"> • When the power to the hob is switched off, there will be no 'hot surface' indication but the cooking zone may still be hot! Take extreme care. • Heavy-duty scourers, some nylon scourers and harsh/abrasive cleaning agents may scratch the glass. Always read the label to check if your cleaner or scourer is suitable. • Never leave cleaning residue on the hob: the glass may become stained.
<p>Boilovers, melts, and hot sugary spills on the glass</p>	<p>Remove these immediately with a fish slice, palette knife or razor blade scraper suitable for ceramic glass hobs, but beware of hot cooking zone surfaces:</p> <ol style="list-style-type: none"> 1. Switch the power to the hob off at the wall. 2. Hold the blade or utensil at a 30° angle and scrape the soiling or spill to a cool area of the hob. 4. Clean the soiling or spill up with a dish cloth or paper towel. 4. Follow steps 2 to 4 for 'Everyday soiling on glass' as above. 	<ul style="list-style-type: none"> • Remove stains left by melts and sugary food or spill overs as soon as possible. If left to cool on the glass, they may be difficult to remove or even permanently damage the glass surface. • Cut hazard: when the safety cover is retracted, the blade in a scraper is razor-sharp. Use with extreme care and always store safely and out of reach of children.
<p>Spill overs on the touch controls</p>	<ol style="list-style-type: none"> 1. Switch the power to the hob off. 2. Soak up the spill 5. Wipe the touch control area with a clean damp sponge or cloth. 6. Wipe the area completely dry with a paper towel. 7. Switch the power to the hob back on. 	<ul style="list-style-type: none"> • The hob may beep and turn itself off, and the touch controls may not function while there is liquid on them. Make sure you wipe the touch control area dry before turning the hob back on.

HINTS AND TIPS

Problem	Possible causes	What to do
The hob cannot be turned on.	No power.	Make sure the hob is connected to the power supply and that it is switched on. Check whether there is a power outage in your home or area. If you've checked everything and the problem persists, call the manufacturer or retailer.
The touch controls are unresponsive and "LO" displayed on the hob.	The controls are locked.	Unlock the controls. See section 'Using your ceramic hob' for instructions.
The touch controls are difficult to operate.	There may be a slight film of water over the controls or you may be using the tip of your finger when touching the controls.	Make sure the touch control area is dry and use the ball of your finger when touching the controls.
The glass is being scratched.	Rough-edged cookware. Unsuitable, abrasive scourer or cleaning products being used.	Use cookware with flat and smooth bases. See 'Choosing the right cookware'. See 'Care and cleaning'.
Some pans make crackling or clicking noises.	This may be caused by the construction of your cookware (Layers of different metals vibrating differently).	This is normal for cookware and does not indicate a fault.
"H" displayed on one of the cooking zones	Zone is cooling down after use.	This is normal. After use the cooking zone will display "H" until it has cooled sufficiently

TECHNICAL SPECIFICATION

Cooking Hob	eiQC77v3
Cooking Zones	5 Zones
Supply Voltage	220-240V~
Installed Electric Power	8200W
Product Size LxWxH(mm)	770x520x50
Building-in Dimensions AxB (mm)	740x490

Weight and Dimensions are approximate. Because we continually strive to improve our products we may change specifications and designs without prior notice.

INFORMATION FOR DISMANTLING

Do not dismantle the appliance in a way which is not shown in the user manual. The appliance could not be dismantled by user. At the end of life, the appliance should not be disposed of with household waste. Check with you Local Authority or retailer for recycling advice.

electriQ UK SUPPORT

www.electriQ.co.uk/support

www.electriQ.co.uk

Call: 0330 390 3061

Office hours: 9AM - 5PM Monday to Friday

Unit J6, Lowfields Business Park
Lowfields Way, Elland
West Yorkshire, HX5 9DA



Recycling facilities are now available for all customers at which you can deposit your old electrical products. Customers will be able to take any old electrical equipment to participating sites run by their local councils. Please remember that this equipment will be further handled during the recycling process, so please be considerate when depositing your equipment. Please contact the local council for details of your local household waste recycling centres.

PRODUCT FICHE

	Symbol	Value	Unit
Model		eiQC77v3	
Type of hob		Electric hobs	
Number of cooking zones or areas		5 zones	
Heating technology (induction cooking zones and cooking areas, radiant cooking zones, solid plates)		Radiant cooking	
For circular cooking zones or area: diameter of useful surface area per electric heated cooking zone or area, rounded to the nearest 5mm	∅	Left down:15.5 Left up:19.0 Middle: 21.5 Right down:19.0 Right up: 15.5	cm
For non-circular cooking zones or areas length and width of useful surface area per electric heated cooking zone or area rounded to the nearest 5mm	L W		cm
Energy consumption per cooking zone or calculated per kg	EC Electric cooking	Left down: Left up: Middle: Right down: Right up:	Wh/kg
Energy consumption for the hob calculated per kg	EC Electric hob		Wh/kg